

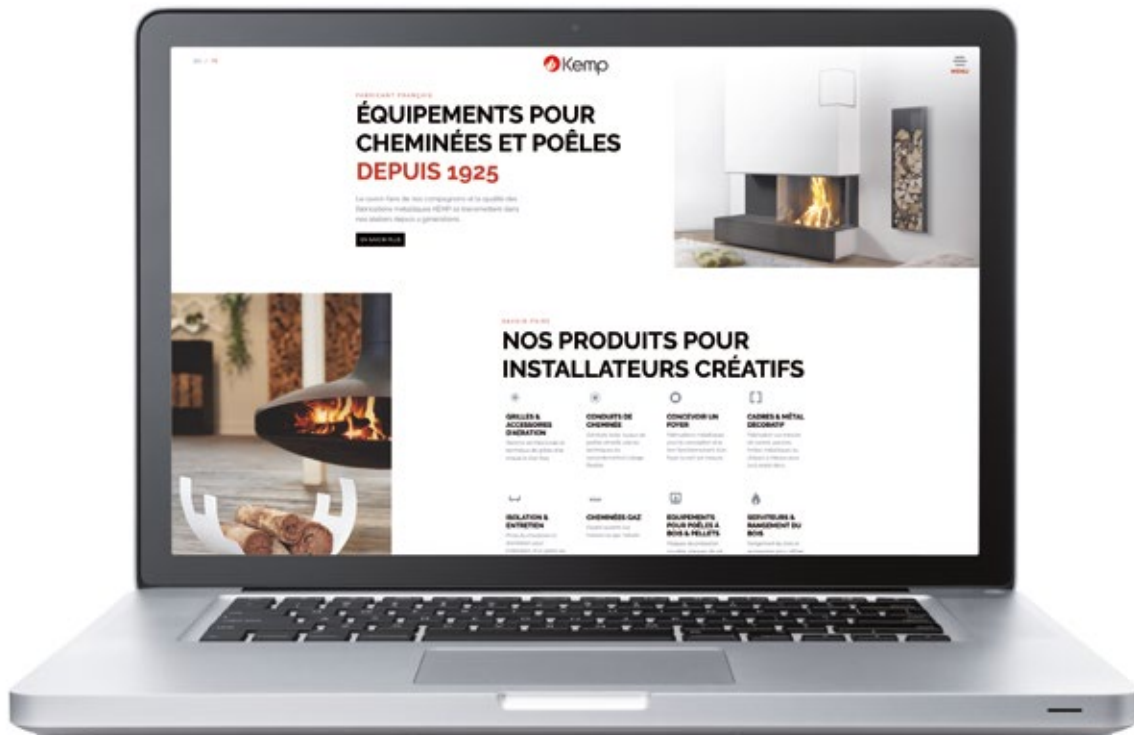

E Q U I P M E N T  
F O R C R E A T I V E I N S T A L L E R S

TECHNICAL & DECORATIVE PRODUCTS FOR STOVES AND FIREPLACES SINCE 1925

# S H A R I N G



[www.kemp-sa.com](http://www.kemp-sa.com)



ALL OUR NOVELTIES & PICTURES OF THE MOST BEAUTIFUL PROJECTS OF OUR CUSTOMERS  
INSTAGRAM #kemp\_steelwork\_fireplace OR LIVE SECTION OF [www.kemp-sa.com](http://www.kemp-sa.com)

# F A I R S



**PROGETTO  
FUOCO**  
Mostra internazionale di impianti ed attrezzature  
per la produzione di calore ed energia dalla combustione di legna

MEET US IN VERONA FROM  
FEBRUARY 23 TO 26, 2022



OUR INDUSTRIAL HERITAGE HELPS US AND PUSHES US TOWARDS INNOVATION  
AND EXCELLENCE TO MEET THE DEMANDS OF OUR CUSTOMERS.



# E - F A C T O R Y



ON [www.kemp-sa.com](http://www.kemp-sa.com)  
DESIGN YOUR PRODUCTS ONLINE !



  
Bienvenue sur notre espace de gestion administrative.

Demander un devis élabore un projet et à développer le produit personnalisé sur votre email.  
L'équipe utilise cet email pour vous envoyer nos notifications.  
Nécessaire ensuite une lettre de fonction, facture et état de paiement.

Votre email  
 [Obtenir mon code](#)

Mon code  
 [Se connecter](#)

Accueil [Niche à bois](#)

**OPTIONS / FINITION**

Coin arrondi :  Couleur :   
Emplacement spot :  Couleur sp. :

**DIMENSIONS (mm)**

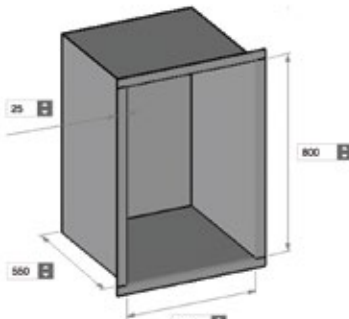

Référence : PHAB-00000800K350-0025-F00-00-ACIER  
Prix unitaire HT :  
Poids :

[Démarrer](#) [Effacer](#) [Mon panier](#)

- Veuillez compléter le formulaire
- Gérez votre modèle et sa référence avec le bouton "Démarrer".
- Le temps de génération peut varier en fonction de la complexité du modèle.

# D E S I G N



WE OFFER BESPOKE, DURABLE, EASY-TO-INSTALL  
PRODUCTS IN ACCORDANCE WITH THE REGULATIONS  
AND DECORATIVE REQUIREMENTS OF THE MARKET.

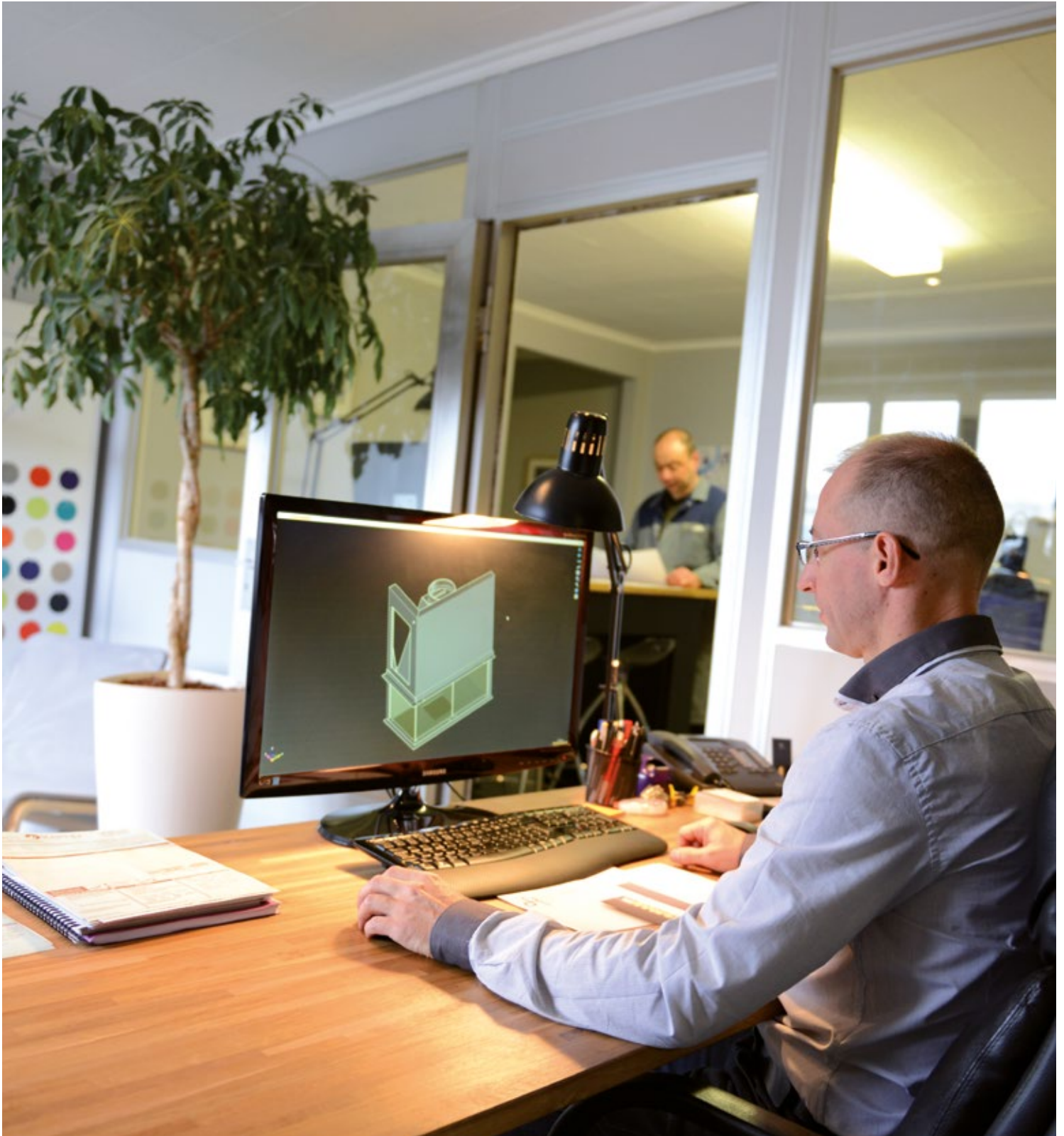







## T H E E X P O W O R K S H O P

A place dedicated to our know-how in fireplace metalwork and metalwork of Art. The old machines of the grandfathers Kemp and Devaux stand alongside our latest productions.



#wedesign#weproduce#wemoveforward

# T E A M



TÉL. +33 (0)1 60 08 95 24



**JACQUES LAPORTE**  
President

---



**JEAN-CHRISTOPHE LAPORTE**  
General Manager  
jclaporte@kemp-sa.com

---



**STÉPHANIE LAPORTE**  
Export Products Ambassador  
slaporte@kemp-sa.com

---



**OLGA KASYANCHUK**  
Export Products Ambassador  
olga@kemp-sa.com

---



**FRANCK WEISS**  
Customized Design Bureau  
fweiss@kemp-sa.com

---



**VALÉRIE ROUGET**  
Sales Administration  
commande@kemp-sa.com

---



**ROBIN PIGNARD**  
France Products Ambassador  
robin@kemp-sa.com

---



**SABER CHERIFI**  
Business development  
saber@kemp-sa.com

---



**BRUNO PINAULT**  
Operations manager

---

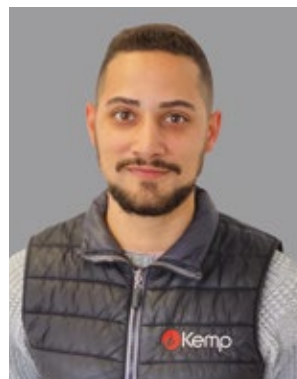

**KÉVIN DIGUET**  
Logistics manager

---

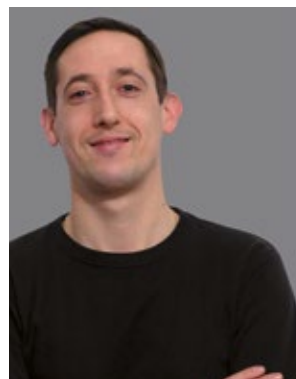

**JOSEPH HEISSAT**  
Designer

---



**GILLES HEISSAT**  
Designer

---

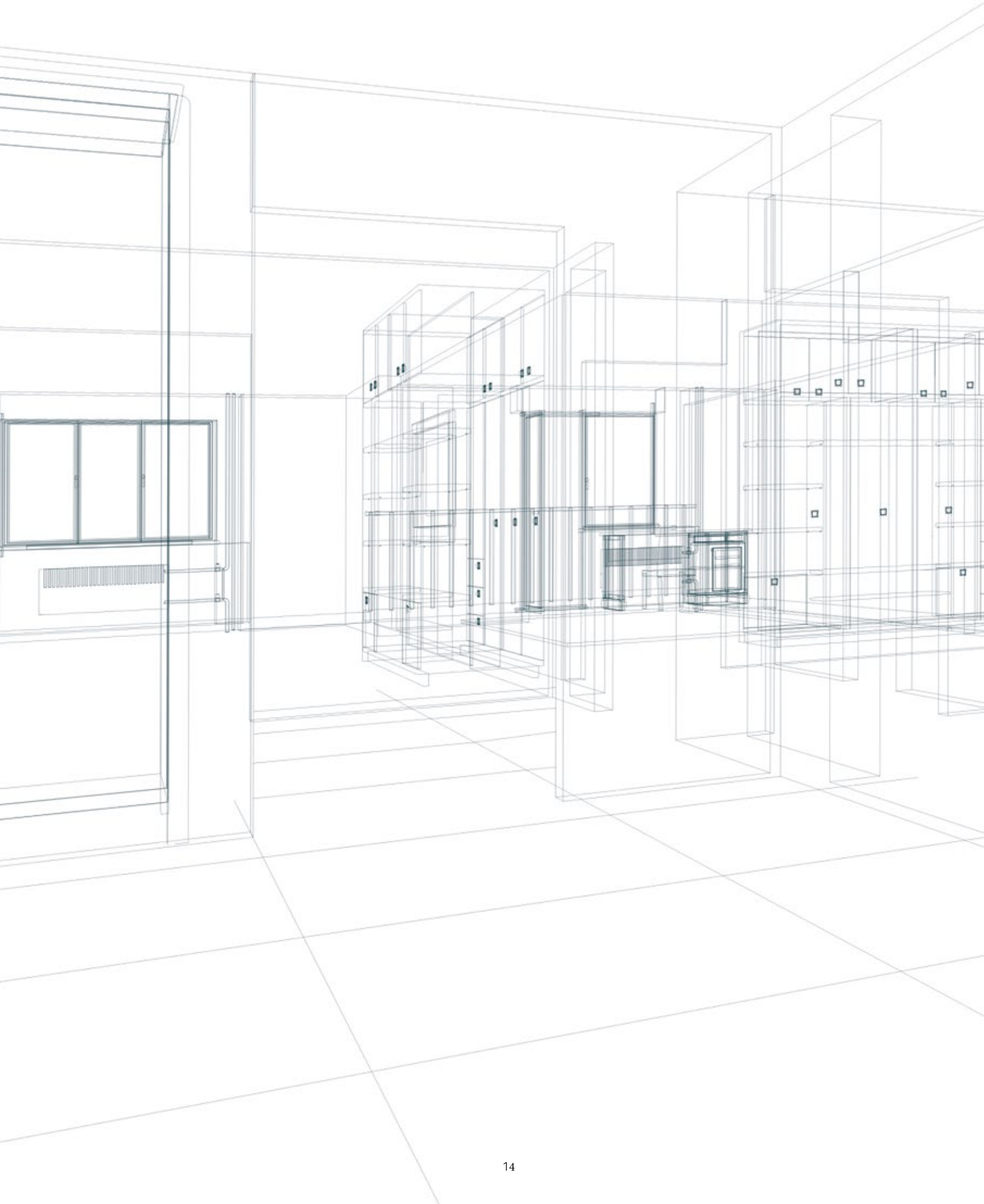





# R I B B E D   S T E E L F I R E P L A C E

Unique piece in 10 mm thick raw steel.  
Ribbed steel pattern on sliding door and hearth.  
Customized fireplace pipe.

Big O wood box (see p.129)

Our metal cladding fits the closed fireplace of your choice.

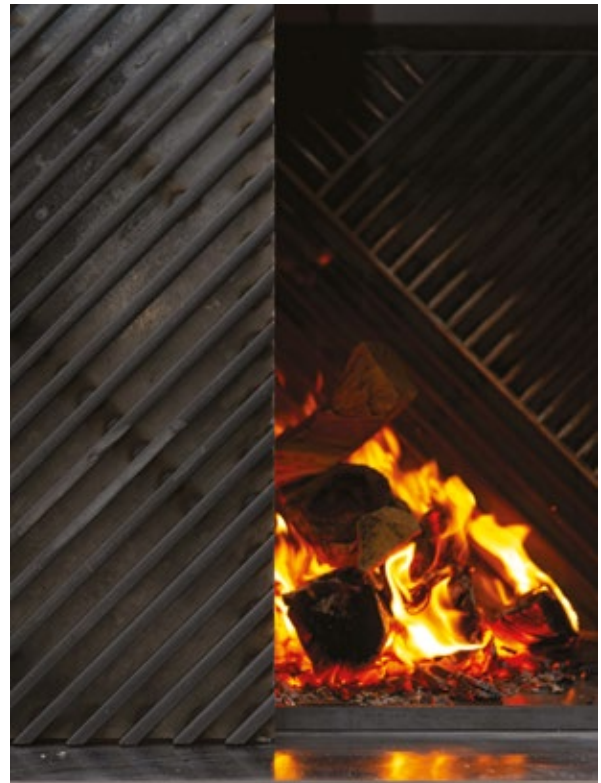





C U S T O M I Z E D  
M E T A L  
H O O D

Customized production of a steel hood treated with high temperature resistant matt black paint. Double skin system and fresh air intake through the base. Unique piece available on request.

Élysée log holder (see p.123)







R I B B E D   A N D  
O X I D I S E D  
B R A S S

Steel and ribbed brass fireplace project.  
Bench seat in matt black lacquered steel,  
3-sided retractable Vitroflam (see p.36)

Our metal cladding fits the closed fireplace of your choice.





H O T  
L A M I N A T E D  
R A W S T E E L

Vitrorama suspended, 4 independent retractable glasses (see p.36)

Modular bench made up of 8 cubes on wheels, varnished raw steel hood with hollow gaskets and invisible fixing

Unique piece available on request.

Our metal cladding fits the closed fireplace of your choice.



# G A S F I R E P L A C E

Manufacture of a ribbed steel hearth  
with retractable Paroflam (see p.37)

KALFIRE gas ramp (see p.45) embedded  
in a customized concrete bench.

Invisible trap doors system and Gas/Electricity management  
developed by our design office.

New LINE 1200 vent (see p.69)

Our metal cladding fits the closed fireplace of your choice.





# C H O O S I N G   T H E   P E R F E C T   F I N I S H I N G

## OPEN OR CLOSED FIRE

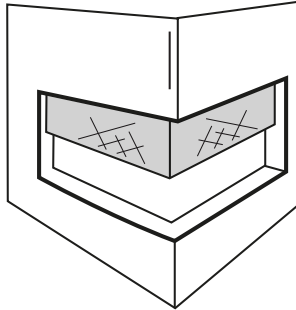

RETRACTABLE DOOR  
WITH GLASS OR WIRE MESH

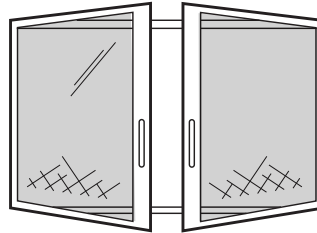

DOOR WITH 1 OR 2 WINGS  
STEEL OR BRASS  
SEALED OR NON-SEALED

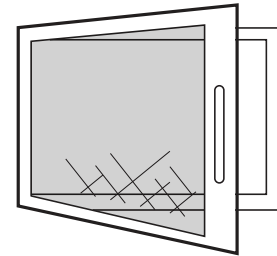

ADAPTABLE TO THE FIREPLACE  
OF YOUR CHOICE

## COLOURS

Our metal workshop offers a variety of finishing touches to give your fireplace a unique character



MATT BLACK



STAINLESS  
STEEL



BRUSHED  
COPPER



BRONZE



STAIN



METAL



BRASS  
(POLISHED,  
VARNISHED,  
SATIN-FINISHED,  
OXIDISED, ETC.)



RAW STEEL



LEATHER

250+ RAL COLOURS



A B U R N I N G P A S S I O N  
F O R U N I Q U E P I E C E S



(HESTIA production)

RIBBED STEEL GAS FIRE & PATINATED BRASS HOOD

1 0 0 % C U S T O M I Z E D P R O D U C T I O N



PRODUCTION OF LES COMPAGNONS D'OVRAIGNE

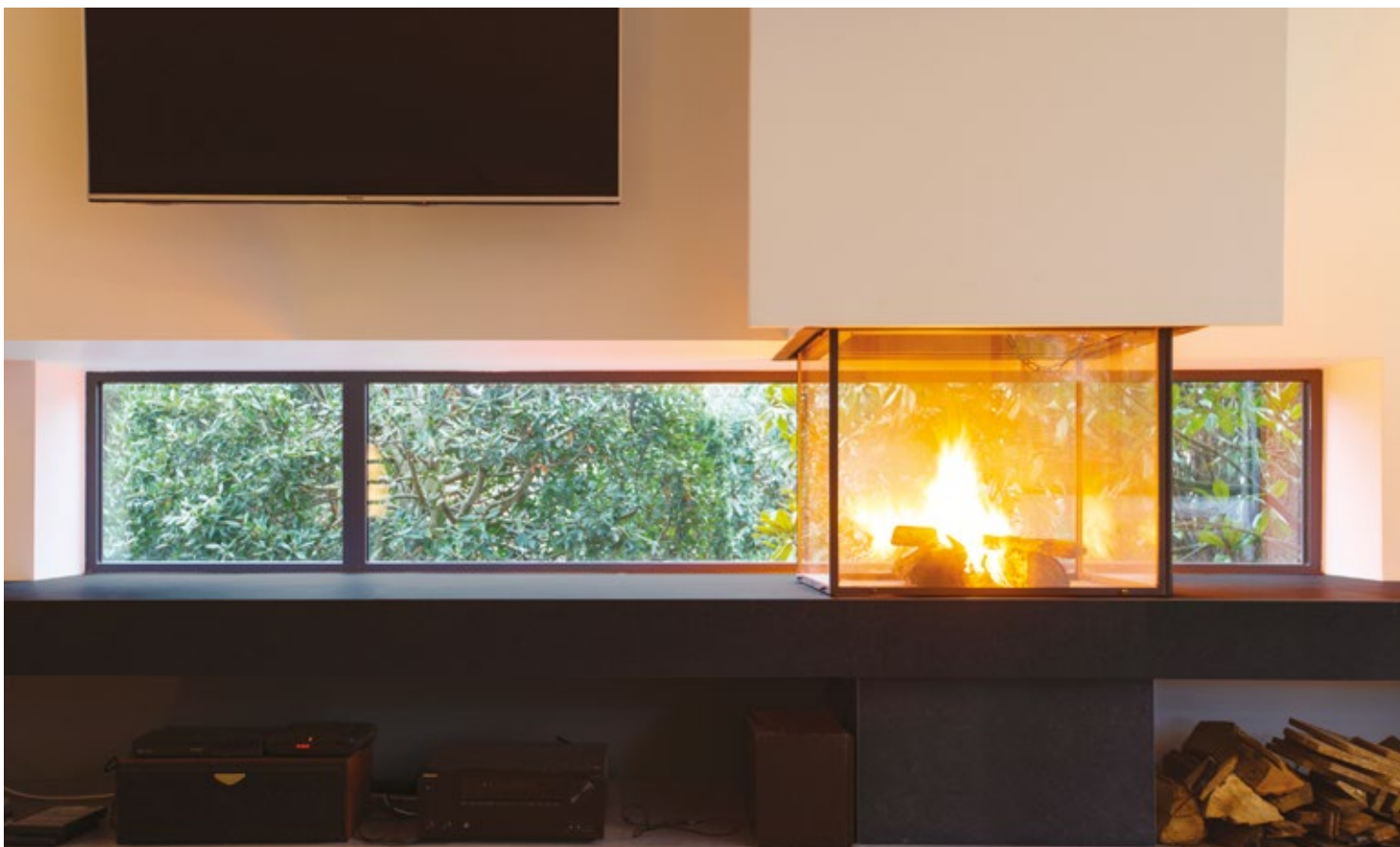

PRODUCTION OF INCANDESCENCE

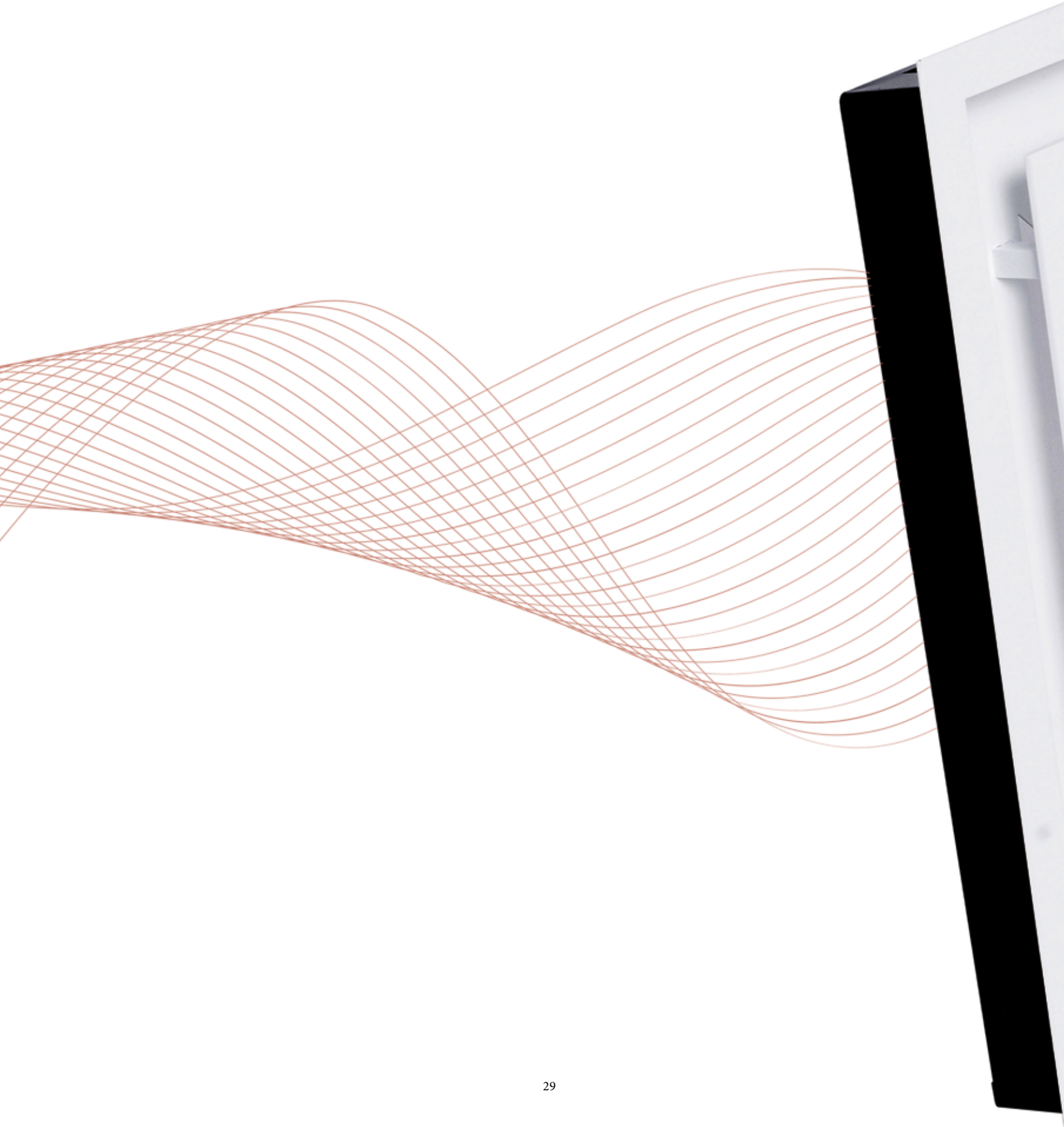





SIMPLIFIED FORMWORK CONSTRUCTION & INVISIBLE VENTILATION

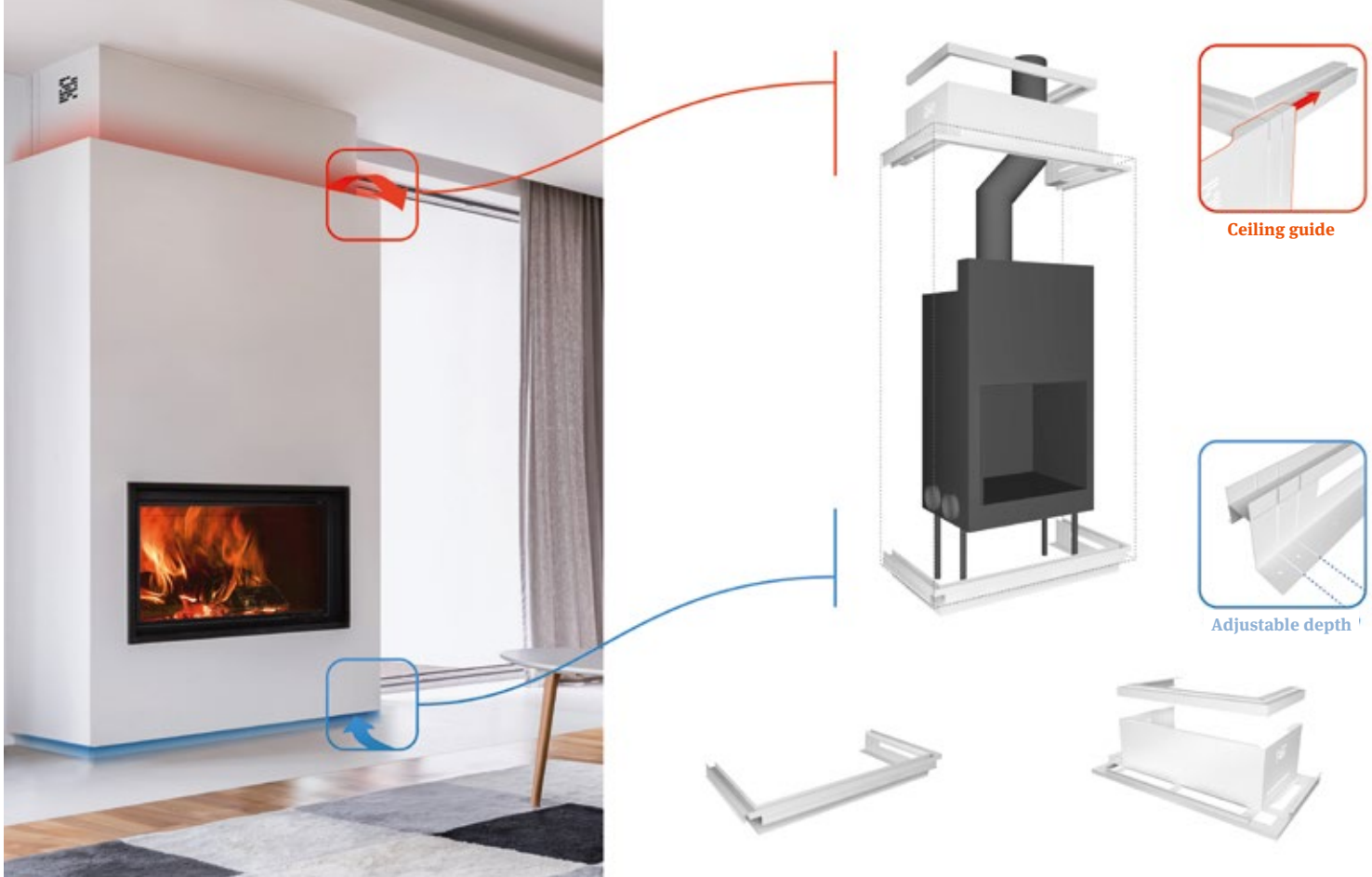

**+ PRODUCT**

- + Reduces formwork assembly time
- + Facilitates the installation work of the installers
- + Allows you to create an offset skirting board on the floor very easily (visual lightness of the formwork)
- + The air vents are no longer visible at all
- + High airflow
- + Adaptable to many materials

| REF     | DESCRIPTION                               | SIZES         | AIRFLOW                                  | MOQ |
|---------|---|---------------|--|-----|
| PEB120B | PERFORM' VENT<br>LOW WIDTH 1200 mm WHITE  | 1174 x 587 mm | 600 cm <sup>2</sup>                      | 1   |
| PEB140B | PERFORM' VENT<br>LOW WIDTH 1400 mm WHITE  | 1374 x 587 mm | 660 cm <sup>2</sup>                      | 1   |
| PEH120B | PERFORM' VENT<br>HIGH WIDTH 1200 mm WHITE | 1174 x 587 mm | 600 cm <sup>2</sup> + 70 cm <sup>2</sup> | 1   |
| PEH140B | PERFORM' VENT<br>HIGH WIDTH 1400 mm WHITE | 1374 x 587 mm | 660 cm <sup>2</sup> + 70 cm <sup>2</sup> | 1   |

WATCH THE INSTALLATION DEMONSTRATION ON YOUTUBE 



SIMPLIFIED FORMWORK CONSTRUCTION FOR CHANNELABLE PELLET STOVES

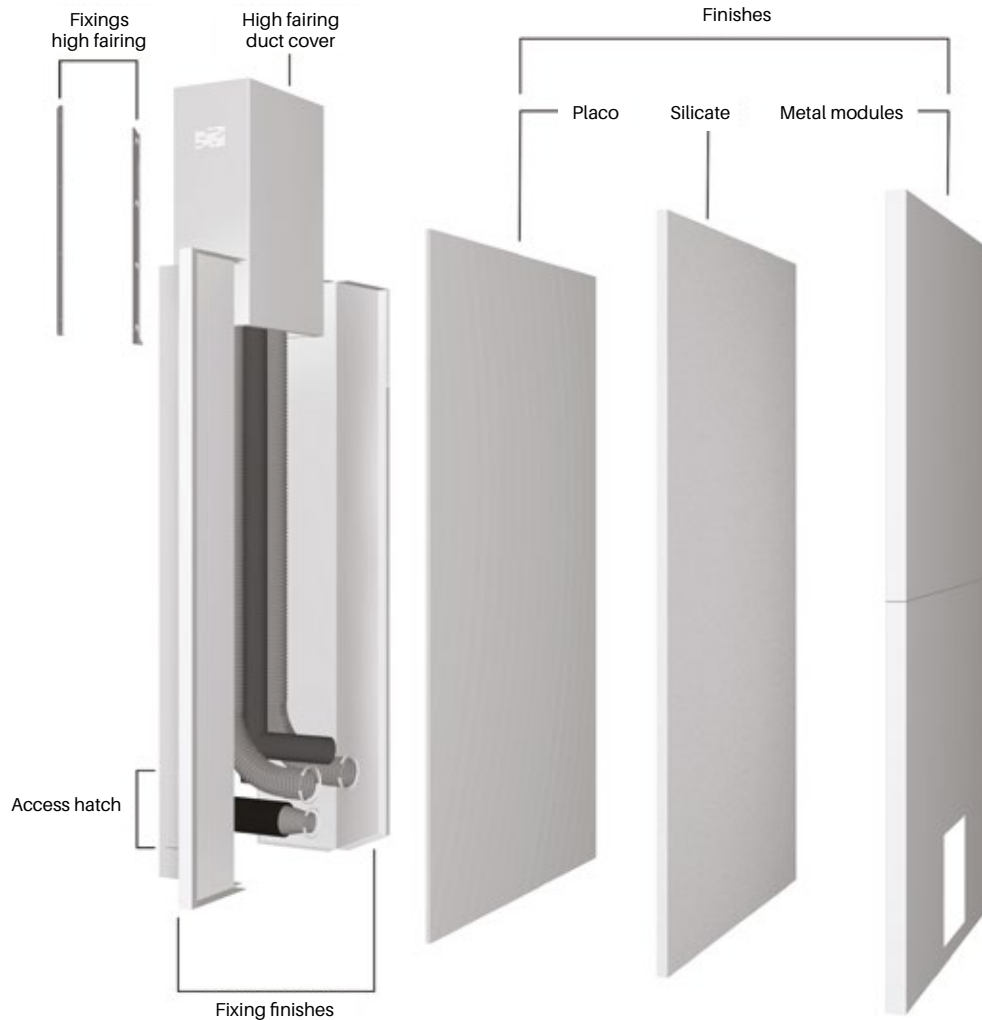

**+ PRODUCT**

- + Conceals ductwork and warm air distribution ducts
- + Reduces formwork assembly time
- + Adaptable to many materials
- + Allows a pellet or vacuum bag to be hidden
- + Adjustable width, minimum 1200 mm

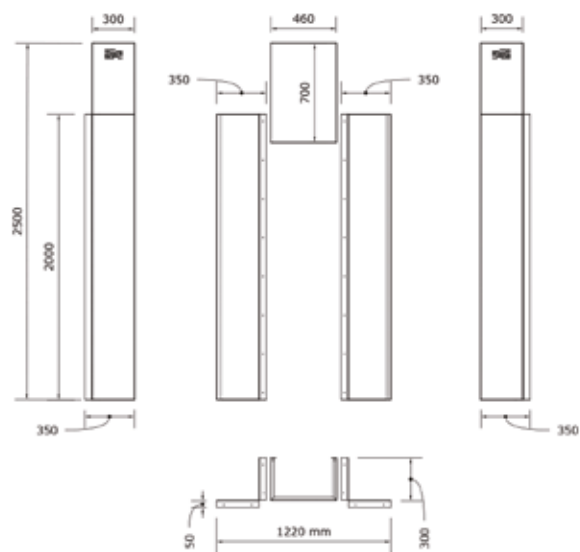

| REF.       | DESCRIPTION                      | COLOUR            | SIZES          | MOQ |
|------------|----------------------------------|-------------------|----------------|-----|
| PERFPELLET | PERFORM' PELLET WHITE            |                   | SEE ABOVE      | 1   |
| OHMPERPEBS | METAL CLADDING OPTION, 2 MODULES | TEXTURED WHITE    | 1200 x 1000 mm | 1   |
| OHMPERPENS | METAL CLADDING OPTION, 2 MODULES | SANDBLASTED BLACK | 1200 x 1000 mm | 1   |





Patented model

MOUNTING ON PRE-FRAME OR HOUSING (TO ORDER SEPARATELY)

NEW



OR

+



**+ PRODUCT**

- + The most discreet vent on the market
- + Large free airflow
- + Quick installation on pre-frame
- + 15 mm edges
- + Connection Ø 125 or 150

| REF         | DESCRIPTION   | SIZES                    | AIRFLOW             | MOQ |
|-------------|---|--------------------------|---------------------|-----|
| BFP1206B    | WHITE FALSE CEILING DECOMPRESSION (set of 2)            | 150 x 95 mm              | 47 cm <sup>2</sup>  | 2   |
| BFP1206N    | BLACK FALSE CEILING DECOMPRESSION (set of 2)            | 150 x 95 mm              | 47 cm <sup>2</sup>  | 2   |
| AIR02-4425B | WHITE FORMWORK VENT (choose pre-frame or housing below) | 440 x 250 mm             | 300 cm <sup>2</sup> | 10  |
| AIR02-4425N | BLACK FORMWORK VENT (choose pre-frame or housing below) | 440 x 250 mm             | 300 cm <sup>2</sup> | 10  |
| PC4425      | PRE-FRAME FOR AIR02-4425 B OR W                         | 418 x 225 mm (EMBEDDING) |                     | 10  |
| BD4425-125  | HOUSING DIAM. 125 FOR AIR02-4425 B (WHITE) OR N (BLACK) | 418 x 225 mm (EMBEDDING) |                     | 10  |
| BD4425-150  | HOUSING DIAM. 150 FOR AIR02-4425 B (WHITE) OR N (BLACK) | 418 x 225 mm (EMBEDDING) |                     | 10  |
| AIR02-3535B | WHITE FORMWORK VENT (choose pre-frame or housing below) | 350 x 350 mm             | 300 cm <sup>2</sup> | 10  |
| AIR02-3535N | BLACK FORMWORK VENT (choose pre-frame or housing below) | 350 x 350 mm             | 300 cm <sup>2</sup> | 10  |
| PC3535      | PRE-FRAME FOR AIR02-3535                                | 320 x 320 mm (EMBEDDING) |                     | 10  |
| BD3535-125  | HOUSING DIAM. 125 FOR AIR02-3535 B (WHITE) OR N (BLACK) | 320 x 320 mm (EMBEDDING) |                     | 10  |
| BD3535-150  | HOUSING DIAM. 150 FOR AIR02-3535 B (WHITE) OR N (BLACK) | 320 x 320 mm (EMBEDDING) |                     | 10  |

ARCHITECTURE AIR'02 XL RANGE



| REF           | DESCRIPTION   | SIZES        | AIRFLOW             | MOQ |
|---------------|---|--------------|---------------------|-----|
| AIRO2-XL-900B | WHITE FORMWORK VENT (choose pre-frame or housing below) | 900 x 250 mm | 600 cm <sup>2</sup> | 1   |
| AIRO2-XL-900N | BLACK FORMWORK VENT (choose pre-frame or housing below) | 900 x 250 mm | 600 cm <sup>2</sup> | 1   |
| PCXL900       | PRE-FRAME FOR AIR'02 XL 900                             | 878 x 225 mm |                     | 1   |
| BDXL-900-150  | 4 CONNECTION HOUSING DIAM. 150 FOR AIR'02 XL 900        | 878 x 225 mm |                     | 1   |



| REF             | DESCRIPTION   | SIZES         | AIRFLOW             | MOQ |
|-----------------|---|---------------|---------------------|-----|
| AIRO2-XXL-1800B | WHITE FORMWORK VENT (choose pre-frame or housing below) | 1800 x 250 mm | 660 cm <sup>2</sup> | 1   |
| AIRO2-XXL-1800N | BLACK FORMWORK VENT (choose pre-frame or housing below) | 1800 x 250 mm | 660 cm <sup>2</sup> | 1   |
| PCXXL-1800      | PRE-FRAME FOR AIR'02 XXL 1800                           | 1778 x 225 mm |                     | 1   |
| BDXXL-1800-150  | 4 CONNECTION HOUSING DIAM. 150 FOR AIR'02 XXL 1800      | 1778 x 225 mm |                     | 1   |



V E N T I L A T I O N   W I T H   T E C H N I C A L   A C C E S S   F O R  
G A S   A N D   P E L L E T   F I R E P L A C E



| REF        | DESCRIPTION                                | SIZES                          | AIRFLOW             | MOQ |
|------------|--|--------------------------------|---------------------|-----|
| 3535TRAPB  | ACCESS HATCH TO FORMWORK (WHITE) + AIRFLOW | 350 x 350 mm                   | 300 cm <sup>2</sup> | 10  |
| PC3535     | PRE-FRAMES FOR 3535TRAPB                   | 320 x 320 mm (EMBEDDING)       |                     | 5   |
| BD3535-200 | FILLING BOX FOR PELLETT INSERT             | Ø 200 + EMBEDDING 320 x 320 mm |                     | 1   |

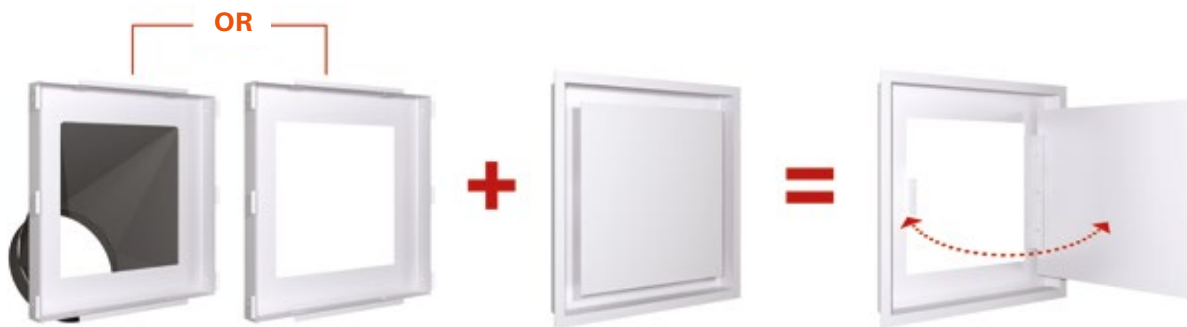



# ARCHITECTURE SOHO' RANGE

AVAILABLE IN BLACK AND WHITE



INSTALLATION INSTRUCTIONS AVAILABLE ON: [kemp-sa.com/en/product/soho](http://kemp-sa.com/en/product/soho)

| REF                       | DESCRIPTION                          | SIZES         | DEPTH                         | AIRFLOW            | MOQ                 |
|---------------------------|--------------------------------------|---------------|-------------------------------|--------------------|---------------------|
| <b>STRAIGHT VENTS</b>     |                                      |               |                               |                    |                     |
| S01809                    | FALSE CEILING VENT WITH PRE-FRAME    | 180 X 90 mm   | EMBEDDING : 160 X 70 mm       | 70 cm <sup>2</sup> | 2                   |
| S02222                    | FORMWORK VENT WITH PRE-FRAME         | 220 X 220 mm  | EMBEDDING : 200 x 200 mm      | 210 mm overall     | 320 cm <sup>2</sup> |
| S03713                    | FORMWORK VENT WITH PRE-FRAME         | 370 X 130 mm  | EMBEDDING : 350 X 110 mm      | 165 mm overall     | 300 cm <sup>2</sup> |
| S07413                    | FORMWORK VENT WITH PRE-FRAME         | 740 X 130 mm  | EMBEDDING : 720 X 110 mm      | 130 mm overall     | 600 cm <sup>2</sup> |
| S09011                    | FORMWORK VENT WITH PRE-FRAME         | 900 X 110 mm  | EMBEDDING : 880 X 90 mm       | 145 mm overall     | 600 cm <sup>2</sup> |
| S012010                   | FORMWORK VENT WITH PRE-FRAME         | 1200 X 100 mm | EMBEDDING : 1180 X 80 mm      | 150 mm overall     | 650 cm <sup>2</sup> |
| <b>ANGLE VENTS</b>        |                                      |               |                               |                    |                     |
| S05050A                   | ANGLE VENT WITH PRE-FRAME            | 500 X 500 mm  | EMBEDDING : 490 X 490 X 90 mm | 145 mm overall     | 530 cm <sup>2</sup> |
| S07030AG                  | LEFT ANGLE VENT WITH PRE-FRAME       | 700 X 300 mm  | EMBEDDING : 690 X 287 X 90 mm | 145 mm overall     | 530 cm <sup>2</sup> |
| S07030AD                  | RIGHT-HAND ANGLE VENT WITH PRE-FRAME | 700 X 300 mm  | EMBEDDING : 690 X 287 X 90 mm | 145 mm overall     | 530 cm <sup>2</sup> |
| <b>CONNECTION OPTIONS</b> |                                      |               |                               |                    |                     |
| OS0125                    | CONNECTION OPTION Ø 125              |               |                               |                    | 1                   |
| OS0150                    | CONNECTION OPTION Ø 150              |               |                               |                    | 1                   |

Available colours White or Black: add B (white) or N (black) at the end of each reference to place your order



CONNECTION OPTION

SOHO LAMELLES : SHORT MODEL IN DEPTH (see p.67)

WATCH THE INSTALLATION DEMONSTRATION ON YOUTUBE 









SOHO STANDARD DEPTH

SOHO SHORTENED DEPTH

# ARCHITECTURE SOHO LAMELLES RC RANGE

AVAILABLE IN BLACK AND WHITE



## + PRODUCT

- + The slats block the view from inside the formwork.
- + Shortened to 65 mm to avoid banging into the hearth base for fresh air intake.

| REF                   | DESCRIPTION                          | SIZES                                     | DEPTH         | AIRFLOW             | MOQ |
|-----------------------|--------------------------------------|---|---------------|---------------------|-----|
| <b>STRAIGHT VENTS</b> |                                      |   |               |                     |     |
| S03713 RC             | FORMWORK VENT WITH PRE-FRAME         | 370 x 130 mm EMBEDDING: 350 x 110 mm      | 65 mm overall | 300 cm <sup>2</sup> | 2   |
| S07413 RC             | FORMWORK VENT WITH PRE-FRAME         | 740 x 130 mm EMBEDDING: 720 x 110 mm      | 65 mm overall | 600 cm <sup>2</sup> | 2   |
| S09011 RC             | FORMWORK VENT WITH PRE-FRAME         | 900 x 110 mm EMBEDDING: 880 x 90 mm       | 65 mm overall | 600 cm <sup>2</sup> | 2   |
| S012010 RC            | FORMWORK VENT WITH PRE-FRAME         | 1200 x 100 mm EMBEDDING: 1180 x 90 mm     | 65 mm overall | 640 cm <sup>2</sup> | 2   |
| <b>ANGLE VENTS</b>    |                                      |   |               |                     |     |
| S05050A RC            | ANGLE VENT WITH PRE-FRAME            | 500 x 500 mm EMBEDDING: 490 x 490 x 90 mm | 65 mm overall | 530 cm <sup>2</sup> | 1   |
| S07030AG RC           | LEFT ANGLE VENT WITH PRE-FRAME       | 700 x 300 mm EMBEDDING: 690 x 287 x 90 mm | 65 mm overall | 530 cm <sup>2</sup> | 1   |
| S07030AD RC           | RIGHT-HAND ANGLE VENT WITH PRE-FRAME | 700 x 300 mm EMBEDDING: 690 x 287 x 90 mm | 65 mm overall | 530 cm <sup>2</sup> | 1   |

AVAILABLE COLOURS WHITE OR BLACK: ADD B (WHITE) OR N (BLACK) AT THE END OF EACH REFERENCE TO PLACE YOUR ORDER



SOHO STANDARD

SOHO SHORTENED



SOHO STANDARD

SOHO SHORTENED

WATCH THE INSTALLATION DEMONSTRATION ON YOUTUBE 



A white, cube-shaped speaker with a circular driver on the front face, positioned on the left side of the mantel.

A row of books on the mantel, including titles like "JEAN PROUVE", "MATRIE D'EXCEPTION", "ANSELM KIEFER STUDIOS", and "FROM WITH A VIEW".

A bronze sculpture consisting of several curved, parallel bars that form a stylized, abstract shape, located in the foreground on the left.

A square coffee table with a wire mesh top and legs, holding several books on the surface.



**+ PRODUCT**

- + Design and discretion
- + No inside view
- + Glue-on fixing
- + Ideal for frontal installation

| REF      | DESCRIPTION                 | SIZES                                       | AIRFLOW             | MOQ |
|----------|-----------------------------|---|---------------------|-----|
| LINE300  | BLACK FORMWORK VENT TO GLUE | 300 mm x 50 mm EMBEDDING : 282 mm x 32 mm   | 70 cm <sup>2</sup>  | 4   |
| LINE600  | BLACK FORMWORK VENT TO GLUE | 600 mm x 50 mm EMBEDDING : 582 mm x 32 mm   | 140 cm <sup>2</sup> | 4   |
| LINE900  | BLACK FORMWORK VENT TO GLUE | 900 mm x 50 mm EMBEDDING : 882 mm x 32 mm   | 210 cm <sup>2</sup> | 4   |
| LINE1200 | BLACK FORMWORK VENT TO GLUE | 1200 mm x 50 mm EMBEDDING : 1182 mm x 32 mm | 280 cm <sup>2</sup> | 1   |



• ATTENTION CHECK THE NORMS OF YOUR COUNTRY TO ADAPT THE NUMBER OF VENTS NECESSARY FOR THE INSTALLATION.



# W A R M   A I R   O U T L E T A R C H I T E C T U R E   M P R   R A N G E

Patented model



| REF     | DESCRIPTION                         | SIZES        |                          | AIRFLOW             | MOQ |
|---------|-------------------------------------|--------------|--------------------------|---------------------|-----|
| MPR 250 | VENT MPR250 + pre-frame             | 250 x 250 mm | EMBEDDING : 235 x 235 mm | 260 cm <sup>2</sup> | 2   |
| MPR 300 | VENT MPR300 + pre-frame             | 300 x 300 mm | EMBEDDING : 285 x 285 mm | 330 cm <sup>2</sup> | 2   |
| MPR 500 | VENT MPR500 + pre-frame             | 500 x 250 mm | EMBEDDING : 485 x 235 mm | 400 cm <sup>2</sup> | 2   |
| OMPR... | HOUSING OPTION Ø 125 OR 150 mm      |              |                          |                     | 2   |
| LIGHT   | OPTION LIGHT SPOT FOR MPR250 OR 300 |              |                          |                     | 1   |

AVAILABLE COLOURS WHITE OR BLACK: ADD B (WHITE) OR N (BLACK) AT THE END OF EACH REFERENCE TO PLACE YOUR ORDER



DELIVERED WITH FIXING  
PRE-FRAME



OPTION : CONNECTION HOUSING  
Ø 150

## + PRODUCT

- + Design and discretion
- + No inside view
- + Ideal for visible frontal installation
- + Option connection housing ø 125 or 150 mm





W A R M   A I R   O U T L E T  
A R C H I T E C T U R E   I N F I N I T Y   R A N G E

Patented model



| REF      | DESCRIPTION                                 | SIZES                                    | AIRFLOW             | MOQ |
|----------|---|--|---------------------|-----|
| INFINITY | FORMWORK VENT (supplied with black housing) | 337 x 177 mm    EMBEDDING : 320 x 155 MM | 300 cm <sup>2</sup> | 10  |

AVAILABLE COLOURS WHITE OR BLACK: ADD B (WHITE) OR N (BLACK) AT THE END OF EACH REFERENCE TO PLACE YOUR ORDER



2 nozzles Ø 150 mm

FRONT VIEW

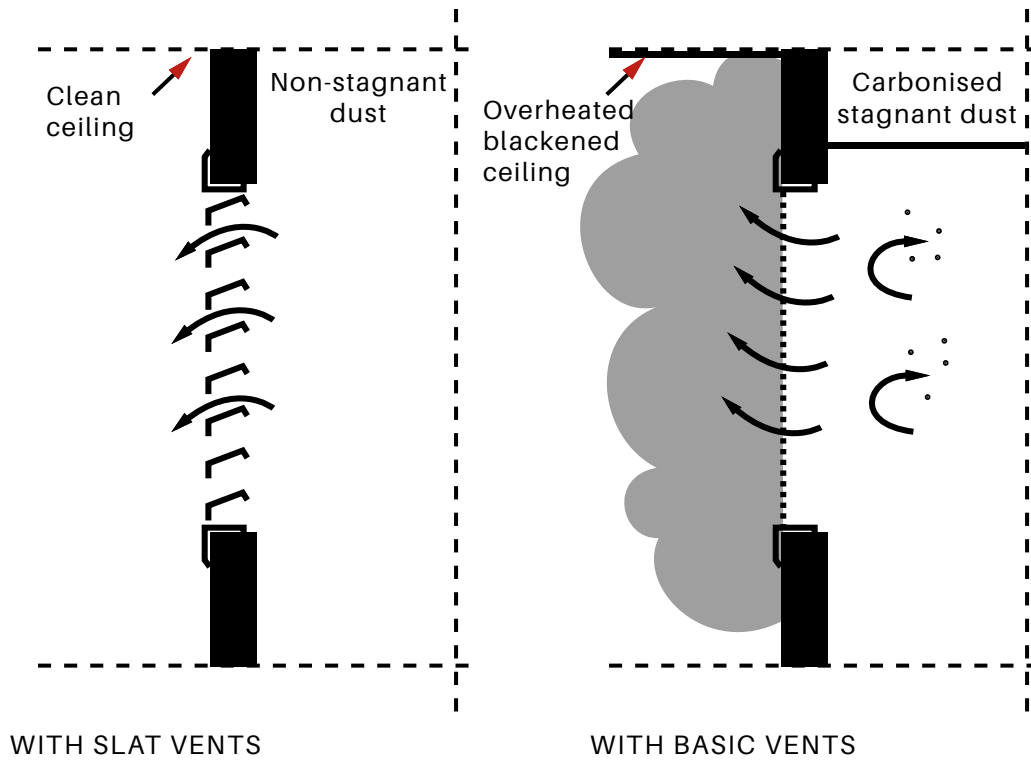
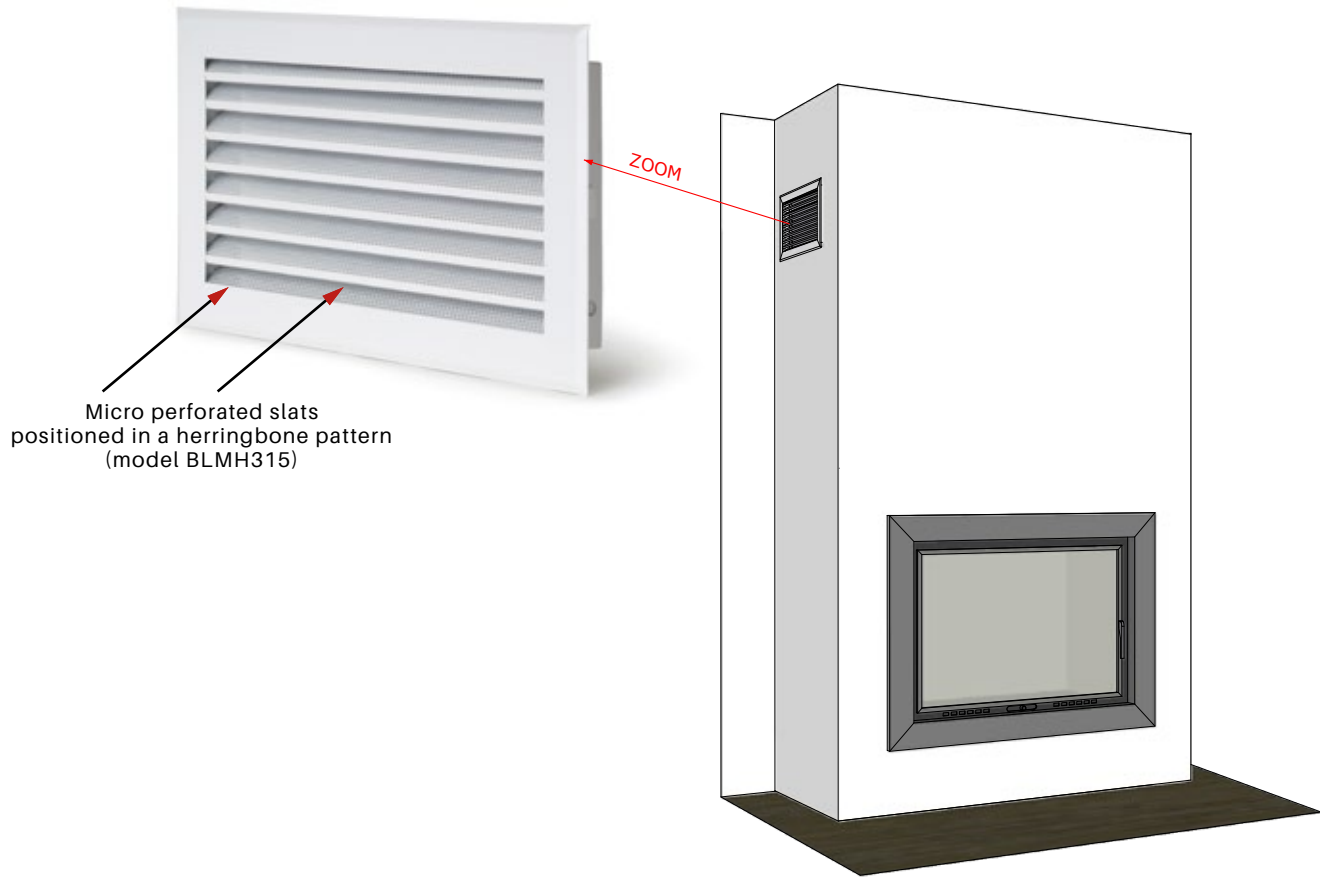

HORIZONTAL VENTS WITH PERFORATED SLATS WITHOUT PRE-FRAME



| REF         | SIZES     | FINISH          | AIRFLOW             | MOQ |
|-------------|-----------|-----------------|---------------------|-----|
| BLMH315B    | 335 x 185 | WHITE           | 360 cm <sup>2</sup> | 20  |
| BLMH315M    | 335 x 185 | MIXED           | 360 cm <sup>2</sup> | 20  |
| BLMH315I    | 335 x 185 | STAINLESS STEEL | 360 cm <sup>2</sup> | 20  |
| BLMH320B... | 320 x 250 | WHITE           | 480 cm <sup>2</sup> | 10  |
| BLMH320M    | 320 x 250 | MIXED           | 480 cm <sup>2</sup> | 10  |
| BLMH515B    | 535 x 185 | WHITE           | 600 cm <sup>2</sup> | 10  |
| BLMH515M    | 535 x 185 | MIXED           | 600 cm <sup>2</sup> | 10  |
| BLMH515I    | 535 x 185 | STAINLESS STEEL | 600 cm <sup>2</sup> | 10  |

PACKING : corresponding housing or pre-frame (see p.77)

DECOMPRESSION VENTS WITH SLATS WITH FRAME

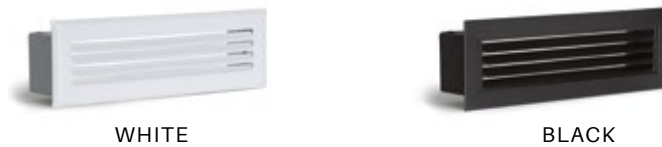

| REF         | SIZES    | FITTING  | FINISH | AIRFLOW            | MOQ |
|-------------|----------|----------|--------|--------------------|-----|
| BFPL100B+PC | 90 x 60  | 75 x 43  | WHITE  | 20 cm <sup>2</sup> | 10  |
| BFPL100N+PC | 90 x 60  | 75 x 43  | BLACK  | 20 cm <sup>2</sup> | 10  |
| BFPL150B+PC | 195 x 60 | 183 x 43 | WHITE  | 47 cm <sup>2</sup> | 10  |
| BFPL150N+PC | 195 x 60 | 183 x 43 | BLACK  | 47 cm <sup>2</sup> | 10  |

# PERFORMANCE RANGE VENTS

## HORIZONTAL FULL SLAT VENTS WITHOUT PRE-FRAME



WHITE

WITH SLOT FOR  
ADAPTATION ON HOUSING  
OR WITHOUT SLOT  
FOR PRE-FRAME



BLACK

| REF                      | SIZES     | FITTING   | FINISH | AIRFLOW             | MOQ |
|--------------------------|-----------|-----------|--------|---------------------|-----|
| BLM150B (with slot)      | 200 x 200 | 163 x 166 | WHITE  | 200 cm <sup>2</sup> | 10  |
| BLMSF150B (without slot) | 200 x 200 | 163 x 166 | WHITE  | 200 cm <sup>2</sup> | 10  |
| BLM150N (with slot)      | 195 x 60  | 163 x 166 | BLACK  | 200 cm <sup>2</sup> | 10  |
| BLMSF150N (without slot) | 195 x 60  | 163 x 166 | BLACK  | 200 cm <sup>2</sup> | 10  |

Choose corresponding pre-frame or housing (see p.77)

## HORIZONTAL FULL SLAT VENTS WITH PRE-FRAME



WHITE  
+ PRE-FRAME



BLACK  
+ PRE-FRAME

| REF      | SIZES     | FITTING   | FINISH | AIRFLOW             | MOQ |
|----------|-----------|-----------|--------|---------------------|-----|
| BLEH315B | 350 x 200 | 307 x 157 | WHITE  | 266 cm <sup>2</sup> | 20  |
| BLEH315N | 350 x 200 | 307 x 157 | BLACK  | 266 cm <sup>2</sup> | 20  |
| BLEH320B | 330 x 250 | 295 x 215 | WHITE  | 355 cm <sup>2</sup> | 20  |
| BLEH320N | 330 x 250 | 295 x 215 | BLACK  | 355 cm <sup>2</sup> | 20  |
| BLRH515B | 550 x 200 | 507 x 157 | WHITE  | 600 cm <sup>2</sup> | 10  |
| BLRH515N | 550 x 200 | 507 x 157 | BLACK  | 600 cm <sup>2</sup> | 10  |
| BLRH715N | 750 x 200 | 707 x 157 | BLACK  | 840 cm <sup>2</sup> | 2   |

Add «SPC» (Without Pre-Frame) to the order number to order the vent without the pre-frame

VERTICAL FULL SLAT VENTS WITHOUT PRE-FRAME



WHITE

BLACK

| REF      | SIZES     | FINISH | AIRFLOW             | MOQ |
|----------|-----------|--------|---------------------|-----|
| BLRV315B | 335 x 185 | WHITE  | 360 cm <sup>2</sup> | 10  |
| BLRV315N | 335 x 185 | BLACK  | 360 cm <sup>2</sup> | 10  |

PRE-FRAMES



PC315



BV3L150



BDR3150



BDR320

| REF   | FITTING   | CORRESP. | MOQ |
|-------|-----------|----------|-----|
| PC150 | 163 x 169 | 150      | 10  |
| PC315 | 307 x 157 | 315      | 20  |
| PC320 | 295 x 215 | 320      | 10  |
| PC515 | 507 x 157 | 515      | 10  |
| PC715 | 707 x 157 | 715      | 2   |

HOUSINGS

| REF        | FITTING   | DIAM.    | MOQ |
|------------|-----------|----------|-----|
| BV3L125    | 163 x 166 | 125 OBT  | 10  |
| BV3L150    | 163 x 166 | 150 OBT  | 10  |
| BDR3125    | 320 x 155 | 125 x 2  | 10  |
| BDR3150    | 320 x 155 | 150 x 2  | 10  |
| BDR320-125 | 295 x 215 | 125 x A2 | 10  |
| BDR5150    | 507 x 157 | 150 x 2  | 10  |
| BDR7150    | 707 x 157 | 150 x 2  | 10  |

« PULSO - K » HOUSING FOR WARM AIR

HOUSING FOR EXTRACTION OF HOT AIR FROM THE HOOD (100° MAX) AND DIRECT DIFFUSION IN THE ROOM WITH INCORPORATED THERMAL CONTACTOR FOR AUTOMATIC RELEASE AT 45°



- NEVER CONNECT THIS UNIT WITH A FLEXIBLE PIPE
- NEVER INSTALL THIS HOUSING ON A HOOD THAT DOES NOT HAVE A DECOMPRESSION VENT

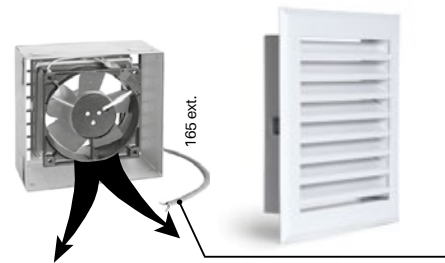

FLOW RATE = 160 M<sup>3</sup>/H

Insulated cable length 1 meter

+ BLM150B  
Not sold with.

| REF     | SIZES         | MOQ |
|---------|---------------|-----|
| PULSO-K | 165 x 165 EXT | 1   |

# ÉCO DÉPLOYÉ VENTS RANGE

## HOOD DROP-CEILING VENTS WITH FRAME



WHITE



BLACK



MIXED



STAINLESS  
STEEL



(see p.87)  
ROUND VENT  
BFPORB

| REF         | SIZES     | FITTING           | FINISH            | AIRFLOW            | MOQ                |    |
|-------------|-----------|-------------------|-------------------|--------------------|--------------------|----|
| BFPO100B+PC | 90 x 60   | 75 x 43           | WHITE             | 20 cm <sup>2</sup> | 10                 |    |
| BFPO100N+PC | 90 x 60   | 75 x 43           | BLACK             | 20 cm <sup>2</sup> | 10                 |    |
| BFPO100M+PC | 90 x 60   | 75 x 43           | MIXED             | 20 cm <sup>2</sup> | 10                 |    |
| BFPO150B+PC | 195 x 60  | 183 x 43          | WHITE             | 47 cm <sup>2</sup> | 10                 |    |
| BFPO150M+PC | 195 x 60  | 183 x 43          | MIXED             | 47 cm <sup>2</sup> | 10                 |    |
| BFPO150I+PC | 195 x 60  | 183 x 43          | STAINLESS STEEL   | 47 cm <sup>2</sup> | 10                 |    |
| BFPO150N+PC | 195 x 60  | 183 x 43          | BLACK             | 47 cm <sup>2</sup> | 10                 |    |
| BFPO10SP    | 90 x 60   | WITHOUT PRE-FRAME | WHITE             | 20 cm <sup>2</sup> | 10                 |    |
| BFPOBSPC    | 195 x 60  | WITHOUT PRE-FRAME | WHITE             | 47 cm <sup>2</sup> | 10                 |    |
| ROUNDS      | BFPORB    | Ø 60              | WITHOUT PRE-FRAME | WHITE              | 20 cm <sup>2</sup> | 10 |
|             | BFPOR80B  | Ø 80              | WITHOUT PRE-FRAME | WHITE              | 30 cm <sup>2</sup> | 10 |
|             | BFPOR100B | Ø 100             | WITHOUT PRE-FRAME | WHITE              | 47 cm <sup>2</sup> | 10 |
|             | BFPOR125B | Ø 125             | WITHOUT PRE-FRAME | WHITE              | 75 cm <sup>2</sup> | 10 |
| BSEDSFB     | 130 x 120 | 113 x 100         | WHITE             | 30 cm <sup>2</sup> | 10                 |    |

## SQUARE VENTS WITH MATCHING SHUTTER CORRESPONDING HOUSINGS WITHOUT PRE-FRAME



WHITE  
WITH SLOT



BLACK



MIXED



STAINLESS  
STEEL

| REF      | SIZES     | FINISH                | AIRFLOW             | CORRESP. | MOQ |
|----------|-----------|-----------------------|---------------------|----------|-----|
| BOE100B  | 150 x 150 | WHITE                 | 78 cm <sup>2</sup>  | BV1100   | 10  |
| BOE100N  | 150 x 150 | BLACK                 | 78 cm <sup>2</sup>  | BV1100   | 10  |
| BOE125B  | 166 x 166 | WHITE                 | 122 cm <sup>2</sup> | BV5125   | 10  |
| BOE125N  | 166 x 166 | BLACK                 | 122 cm <sup>2</sup> | BV5125   | 10  |
| BOE125M  | 166 x 166 | MIXED                 | 122 cm <sup>2</sup> | BV5125   | 10  |
| BOE125I  | 166 x 166 | STAINLESS STEEL       | 122 cm <sup>2</sup> | BV5125   | 10  |
| BOE150B  | 200 x 200 | WHITE                 | 175 cm <sup>2</sup> | BV3L150  | 10  |
| BOE150N  | 200 x 200 | BLACK                 | 175 cm <sup>2</sup> | BV3L150  | 10  |
| BOE150M  | 200 x 200 | MIXED                 | 175 cm <sup>2</sup> | BV3L150  | 10  |
| BOE150I  | 200 x 200 | STAINLESS STEEL       | 175 cm <sup>2</sup> | BV3L150  | 10  |
| BOESF100 | 150 x 150 | WHITE (WITHOUT SLOT)  | 78 cm <sup>2</sup>  | B1100    | 10  |
| BOESF125 | 166 x 166 | WHITE (WITHOUT FENTE) | 122 cm <sup>2</sup> | PC125    | 10  |
| BOESF150 | 200 x 200 | WHITE (WITHOUT FENTE) | 175 cm <sup>2</sup> | PC150    | 10  |

INSTALLATION : CHOOSE A CORRESPONDING HOUSING OR PRE-FRAME (see p.82)

# ÉCO DÉPLOYÉ VENTS RANGE

## VENTS FOR MAIN HOOD DECOMPRESSION WITHOUT PRE-FRAME



WHITE  
WITHOUT SLOT



BLACK



MIXED



STAINLESS STEEL



B06315B

| REF     | SIZES     | FINISH          | AIRFLOW             | MOQ |
|---------|-----------|-----------------|---------------------|-----|
| B0315B  | 350 x 200 | WHITE           | 286 cm <sup>2</sup> | 20  |
| B0315N  | 350 x 200 | BLACK           | 286 cm <sup>2</sup> | 20  |
| B0315M  | 350 x 200 | MIXED           | 286 cm <sup>2</sup> | 20  |
| B0315I  | 350 x 200 | STAINLESS STEEL | 286 cm <sup>2</sup> | 20  |
| B06315B | 350 x 200 | WHITE           | 286 cm <sup>2</sup> | 10  |
| B0320B  | 330 x 250 | WHITE           | 375 cm <sup>2</sup> | 10  |
| B0320M  | 330 x 250 | MIXED           | 375 cm <sup>2</sup> | 10  |
| B0515B  | 550 x 200 | WHITE           | 480 cm <sup>2</sup> | 10  |
| B0515N  | 550 x 200 | BLACK           | 480 cm <sup>2</sup> | 10  |
| B0515M  | 550 x 200 | MIXED           | 480 cm <sup>2</sup> | 10  |
| B0515I  | 550 x 200 | STAINLESS STEEL | 480 cm <sup>2</sup> | 10  |
| B0615B  | 650 x 200 | WHITE           | 575 cm <sup>2</sup> | 10  |
| B0615N  | 650 x 200 | BLACK           | 575 cm <sup>2</sup> | 10  |
| B0615M  | 650 v 200 | MIXED           | 575 cm <sup>2</sup> | 10  |
| B0715B  | 750 x 200 | MIXED           | 675 cm <sup>2</sup> | 10  |

INSTALLATION : CHOOSE A CORRESPONDING HOUSING OR PRE-FRAME (see p.82)

## DECORATIVE VENTS FOR FLOOR USE



BV125B  
Add BV5.125  
for sealable version

| REF    | SIZES     | FINISH | AIRFLOW            | MOQ |
|--------|-----------|--------|--------------------|-----|
| BR125B | 150 x 150 | WHITE  | 80 cm <sup>2</sup> | NO  |
| BR125N | 150 x 150 | BLACK  | 80 cm <sup>2</sup> | NO  |





# TRADITION VENTS

## MOULDED VENTS WITHOUT PRE-FRAME

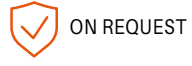

BOM125



WHITE



MIXED

| REF     | SIZES     | FINISH | AIRFLOW             | MOQ |
|---------|-----------|--------|---------------------|-----|
| BOM100B | 150 x 150 | WHITE  | 78 cm <sup>2</sup>  | 10  |
| BOM100M | 150 x 150 | MIXED  | 78 cm <sup>2</sup>  | 10  |
| BOM125B | 175 x 175 | WHITE  | 122 cm <sup>2</sup> | 10  |
| BOM125M | 175 x 175 | MIXED  | 122 cm <sup>2</sup> | 10  |
| BOM150B | 200 x 200 | WHITE  | 175 cm <sup>2</sup> | 10  |
| BOM150M | 200 x 200 | MIXED  | 175 cm <sup>2</sup> | 10  |
| BOM315B | 350 x 200 | WHITE  | 286 cm <sup>2</sup> | 20  |
| BOM315M | 350 x 200 | MIXED  | 286 cm <sup>2</sup> | 20  |
| BOM320B | 320 x 250 | WHITE  | 375 cm <sup>2</sup> | 10  |
| BOM320M | 320 x 250 | MIXED  | 375 cm <sup>2</sup> | 10  |
| BOM515B | 550 x 200 | WHITE  | 480 cm <sup>2</sup> | 10  |
| BOM515M | 550 x 200 | MIXED  | 480 cm <sup>2</sup> | 10  |

## PRE-FRAMES



PC315

| REF   | FITTING   | CORRESP. | MOQ |
|-------|-----------|----------|-----|
| PC150 | 163 x 169 | 150      | 10  |
| PC315 | 307 x 157 | 315      | 20  |
| PC320 | 295 x 215 | 320      | 10  |
| PC515 | 507 x 157 | 515      | 10  |
| PC715 | 707 x 157 | 715      | 2   |

## HOUSINGS



BV3L150



BDR3150



BDR320

| REF        | FITTING   | DIAM.   | MOQ |
|------------|-----------|---------|-----|
| BV3L125    | 163 x 166 | 125 OBT | 10  |
| BV3L150    | 163 x 166 | 150 OBT | 10  |
| BDR3125    | 320 x 155 | 125 X 2 | 10  |
| BDR3150    | 320 x 155 | 150 X 2 | 10  |
| BDR320-125 | 295 x 215 | 125 X 2 | 10  |
| BDR5150    | 507 x 157 | 150 X 2 | 10  |
| BDR7150    | 707 x 157 | 150 X 2 | 10  |

## SIMPLE HOUSINGS



B3150



BDR3150

| REF     | NOZZLE DIAM. | FITTING   | CORRESP. | MOQ |
|---------|--------------|-----------|----------|-----|
| B1100   | Ø 100        | 113 x 116 | 100      | 10  |
| B5125   | Ø 125        | 137 x 140 | 125      | 10  |
| B3150   | Ø 150        | 163 x 166 | 150      | 10  |
| BDR3125 | Ø 125X2      | 320 x 155 | 315      | 10  |
| BDR3150 | Ø 150X2      | 320 x 155 | 315      | 10  |
| BDR5125 | Ø 125X2      | 507 x 157 | 515      | 10  |
| BDR5150 | Ø 150X2      | 507 x 157 | 515      | 10  |

## SEALABLE HOUSINGS



BV3L150

| REF     | NOZZLE DIAM. | FITTING   | CORRESP. | MOQ |
|---------|--------------|-----------|----------|-----|
| BV1100  | Ø 100        | 113 x 116 | 100      | 10  |
| BV5125  | Ø 125        | 137 x 140 | 125      | 10  |
| BV3L150 | Ø 150        | 163 x 166 | 150      | 10  |

## FILTERS

| REF   | PF (PRE-FRAME) | MOQ |
|-------|----------------|-----|
| FS315 | FOR PC315      | 20  |
| FS515 | FOR PC515      | 10  |
| FS615 | FOR PC615      | 10  |
| FS715 | FOR PC715      | 10  |



FS 315

# A C C E S S D O O R S

## ACCESS DOORS WITH PRE-FRAME 350 X 550



| REF    | DESCRIPTION                   | SIZES     | FINISH          | MOQ |
|--------|-------------------------------|-----------|-----------------|-----|
| V0     | FULL DOOR                     | 350 x 550 | RAW             | 1   |
| V0B    | FULL DOOR                     | 350 x 550 | WHITE LACQUERED | 1   |
| V1     | DOOR WITH AIRFLOW AREA        | 350 x 550 | WHITE LACQUERED | 1   |
| VR10B  | FULLY PERFORATED DOOR + EDGES | 350 X 550 | WHITE LACQUERED | 1   |
| VR10ND | FULLY PERFORATED DOOR + EDGES | 350 X 550 | BLACK LACQUERED | 1   |

## «PVK» ACCESS DOORS WITH PRE-FRAME FLAT FRONT OR MOULDING 355X465



| REF  | DESCRIPTION | SIZES     | FINISH | MOQ |
|------|-------------|-----------|--------|-----|
| PVKB | ACCESS DOOR | 355 x 465 | WHITE  | 1   |

## SLATTED ACCESS DOOR WITH PRE-FRAME

| REF   | DESCRIPTION         | SIZES     | FINISH | MOQ |
|-------|---------------------|-----------|--------|-----|
| PVLKB | SLATTED ACCESS DOOR | 355 x 465 | WHITE  | 1   |



## FILTER AND DEFLECTOR FOR «PVK» DOOR

| REF   | DESCRIPTION                       | FINISH | MOQ |
|-------|-----------------------------------|--------|-----|
| FSPVK | SINGLE FILTER IN PERFORATED STEEL | BLACK  | 1   |

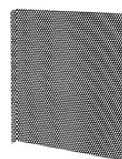

For door type  
PVLKB and PVKB  
(ALSO HIDES THE INTERIOR  
VIEW OF THE HOOD)

AIR O2 hatch (see p.61) and pellet inserts door (see p.114)

# A I R ' 0 2 P E L L E T S

## WARM AIR DISTRIBUTION VENT FOR DUCTABLE STOVES



AIR02-1818B



AIR02-1818N



| REF.        | DESCRIPTION  | SIZES                    | AIRFLOW            | MOQ |
|-------------|--|--------------------------|--------------------|-----|
| AIR02-1818B | WARM AIR DISTRIBUTION VENT (choose pre-frame or housing below) | 180 x 180 mm             | 90 cm <sup>2</sup> | 2   |
| AIR02-1818N | WARM AIR DISTRIBUTION VENT (choose pre-frame or housing below) | 180 x 180 mm             | 90 cm <sup>2</sup> | 2   |
| PC1818      | PRE-FRAME FOR AIR02-1818 B (WHITE) OR N (BLACK)                | 165 x 160 mm (EMBEDDING) |                    | 2   |
| B1818-60    | HOUSING Ø 60 FOR AIR02-1818 B (WHITE) OR N (BLACK)             | 165 x 160 mm (EMBEDDING) |                    | 2   |
| B1818-80    | HOUSING Ø 80 FOR AIR02-1818 B (WHITE) OR N (BLACK)             | 165 x 160 mm (EMBEDDING) |                    | 2   |
| B1818-100   | HOUSING Ø 100 FOR AIR02-1818 B (WHITE) OR N (BLACK)            | 165 x 160 mm (EMBEDDING) |                    | 2   |

Air'02 Range (see p.57)



# C E I L I N G   D I F F U S E R S

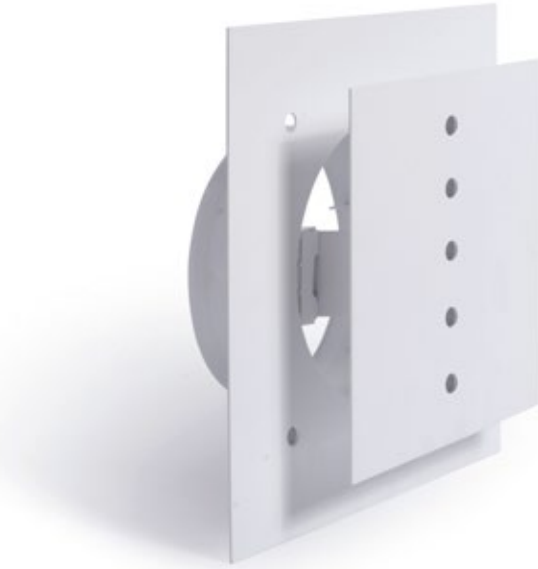

## + PRODUCT

- + Front shutter can be closed.  
Removable for installation and maintenance

## SEALABLE CEILING DIFFUSER

| REF    | DESCRIPTION                          | SIZES | MOQ |
|--------|--------------------------------------|-------|-----|
| DPA80  | WHITE ARCHITECTURAL CEILING DIFFUSER | Ø 80  | 5   |
| DPA100 | WHITE ARCHITECTURAL CEILING DIFFUSER | Ø 100 | 5   |
| DPA125 | WHITE ARCHITECTURAL CEILING DIFFUSER | Ø 125 | 5   |
| DPA150 | WHITE ARCHITECTURAL CEILING DIFFUSER | Ø 150 | 5   |

## CEILING DIFFUSER (ALWAYS DELIVERED WITH PLASTERBOARD SLEEVE)

Finish : White lacquered



OFF-CENTRE PIVOTING SHUTTER

| REF    | DESCRIPTION                  | SIZES | MOQ |
|--------|------------------------------|-------|-----|
| DPR100 | ROUND CEILING DIFFUSER       | Ø 100 | 5   |
| DPD125 | DIRECTIONAL CEILING DIFFUSER | Ø 125 | 5   |
| DPD150 | DIRECTIONAL CEILING DIFFUSER | Ø 150 | 5   |

# VENTS & REDUCTIONS FOR WARM AIR DISTRIBUTION

| REF   | DESCRIPTION  | MOQ |
|---|--|-----|
|  BFPOR60B              | ROUND VENT Ø 60 WITHOUT PRE-FRAME<br>WHITE FINISHING           | 10  |
|  BFPOR80B              | ROUND VENT Ø 80 WITHOUT PRE-FRAME<br>WHITE FINISHING           | 10  |
|  BFPOR100B             | ROUND VENT Ø 100 WITHOUT PRE-FRAME<br>WHITE FINISHING          | 10  |
|  BFPOR125B             | ROUND VENT Ø 125 WITHOUT PRE-FRAME<br>WHITE FINISHING          | 10  |
|  BVFPOR80B            | ROUND VENT Ø 80 SEALABLE<br>WHITE FINISHING                    | 10  |
|  BOESF100B<br>+ B180 | NON SEALABLE VENT 150 X 150 CONNECTION Ø 80<br>WHITE FINISHING | 10  |
|  BOE100B<br>+ BV180  | SEALABLE VENT 150 X 150 CONNECTION Ø 80<br>WHITE FINISHING     | 10  |
|  DPA80               | CEILING DIFFUSER Ø 80  | 1   |
|  R13N                | BLACK ALUMINIUM REDUCTION 80 INSIDE > 59 OUTSIDE               | 1   |
| R14N  | BLACK ALUMINIUM REDUCTION 100 INSIDE > 79 OUTSIDE              | 1   |
| R15N  | BLACK ALUMINIUM REDUCTION 80 INSIDE > 49 OUTSIDE               | 1   |



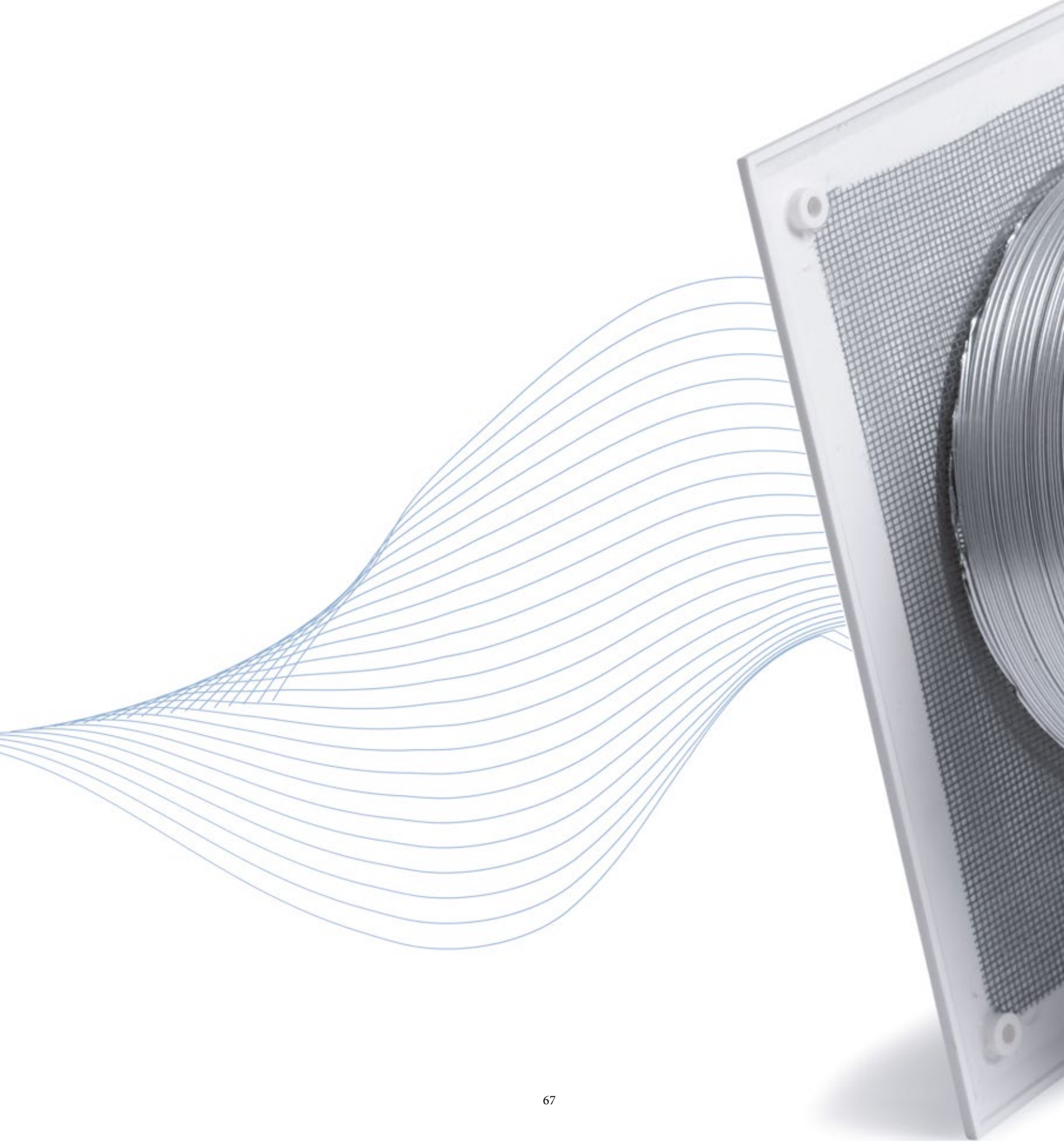

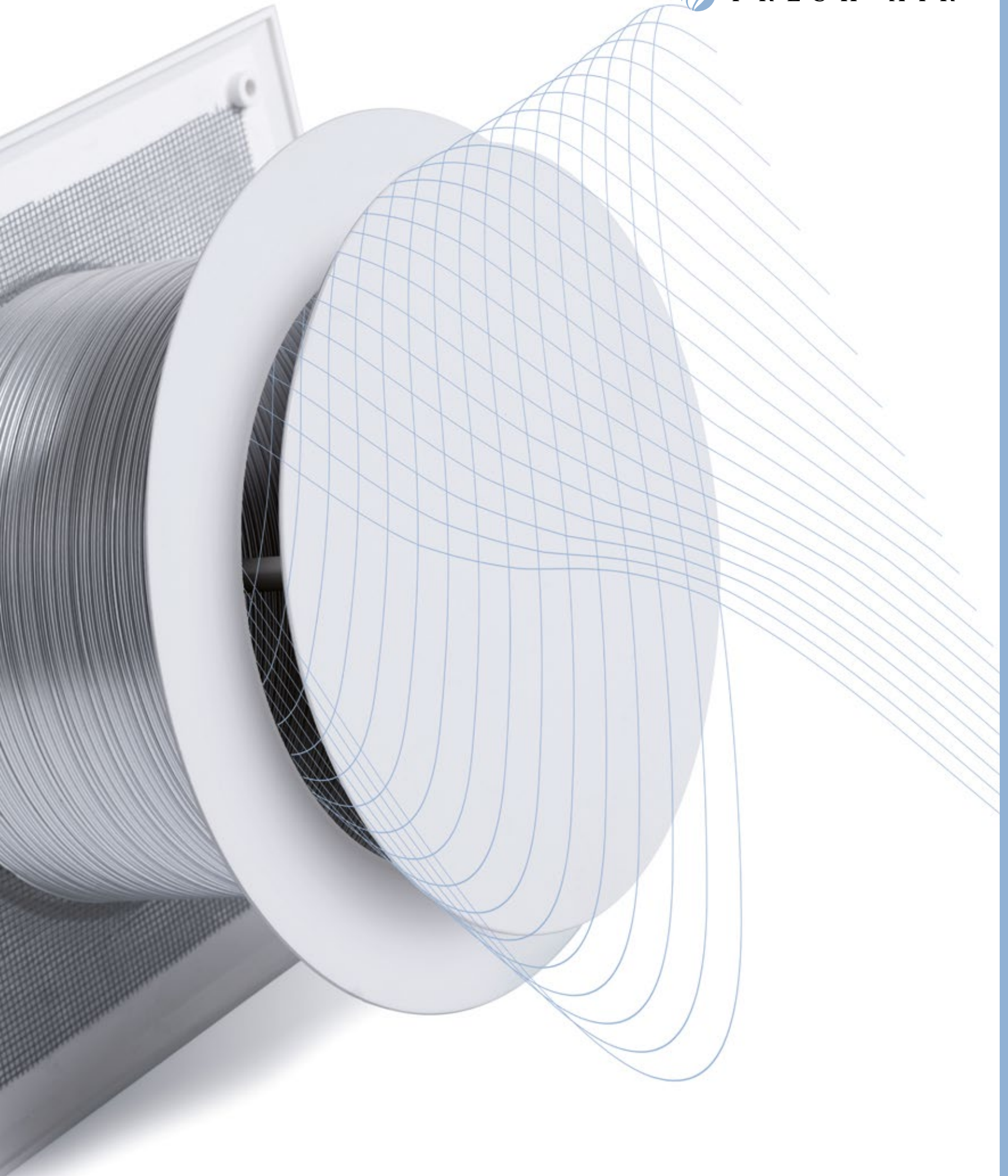

# INDIRECT FRESH AIR INTAKE KITS

Patented model



Kemp 2012®

## CHARACTERISTICS

- ✓ Ø 100, 125 and 160
- ✓ Inner vent can be closed
- ✓ Decorative finishing with invisible mesh in closed position
- ✓ Wide edges for easy installation
- ✓ Flexible wall leadthrough extends to 50 cm
- ✓ PVC outer vent
- ✓ Delivered as a kit in an individual packaging
- ✓ Colours White, Black or Grey (*white only for Ø 160*)



| REF    | DESCRIPTION       | DIAM. | COLOURS              | MOQ           |
|--------|-------------------|-------|----------------------|---------------|
| KEA100 | KIT FOR AIR INLET | 100   | WHITE / BLACK / GREY | 10 Ø 125 EXT. |
| KEA125 | KIT FOR AIR INLET | 125   | WHITE / BLACK / GREY | 10 Ø 145 EXT. |
| KEA160 | KIT FOR AIR INLET | 160   | WHITE                | 10 Ø 220 EXT. |

### FREE AIRFLOWS :

Ø 100 = 52 cm<sup>2</sup>  
(additional fresh air intake)  
Ø 125 = 73 cm<sup>2</sup>  
(compliant for devices up to 16 kw)  
Ø 160 = 120 cm<sup>2</sup>  
(compliant for devices up to 70 kw)

Note : removable closable shutter  
for installations with permanent air intake

AVAILABLE COLOURS : WHITE, BLACK OR GREY  
ADD B (WHITE), N (BLACK) OR G (GREY) AT THE END OF EACH REFERENCE TO PLACE YOUR ORDER

# INDIRECT FRESH AIR INTAKE KITS

Patented model



## CHARACTERISTICS

- ✓ With airtight rosette
- ✓ Ø 100 and 125
- ✓ Closable inner vent
- ✓ Decorative finishing
- ✓ Wide edges for easy installation
- ✓ Flexible wall leadthrough extends to 50 cm
- ✓ PVC outer vent
- ✓ Delivered as a kit in an individual packaging
- ✓ Colours White, Black or Grey



### FREE AIRFLOWS :

Ø 100 = 52 cm<sup>2</sup>  
 (additional fresh air intake)  
 Ø 125 = 73 cm<sup>2</sup>  
 (compliant for devices up to 16 kw)

| REF      | DESCRIPTION       | DIAM. | COLOURS              | MOQ |
|----------|-------------------|-------|----------------------|-----|
| KEAPP100 | KIT FOR AIR INLET | 100   | WHITE / BLACK / GREY | 10  |
| KEAPP125 | KIT FOR AIR INLET | 125   | WHITE / BLACK / GREY | 10  |



# SEALED FRESH AIR INTAKE KIT WITH ARCHITECTURE VENT



## CHARACTERISTICS

- ✓ With airtight rosette
- ✓ Ø 100 and 125
- ✓ Higher airflow
- ✓ Inner vent can be closed
- ✓ Decorative finishing
- ✓ Wide edges for easy installation
- ✓ Flexible wall leadthrough extends to 50 cm
- ✓ Architecture external vent, prevents prevailing winds from entering the house
- ✓ Delivered as a kit in an individual packaging
- ✓ Colours White, Black or Grey

## FREE AIRFLOWS :

Ø 100 = 90 cm<sup>2</sup>  
Ø 125 = 115 cm<sup>2</sup>

| REF           | DESCRIPTION                | DIAM. | COLOURS              | MOQ |
|---------------|----------------------------|-------|----------------------|-----|
| KEAPP100ARCHI | ARCHITECTURE AIR INLET KIT | 100   | WHITE / BLACK / GREY | 10  |
| KEAPP125ARCHI | ARCHITECTURE AIR INLET KIT | 125   | WHITE / BLACK / GREY | 10  |

AVAILABLE COLOURS : WHITE, BLACK OR GREY  
ADD B (WHITE), N (BLACK) OR G (GREY) AT THE END OF EACH REFERENCE TO PLACE YOUR ORDER

# FLEX SOL KIT

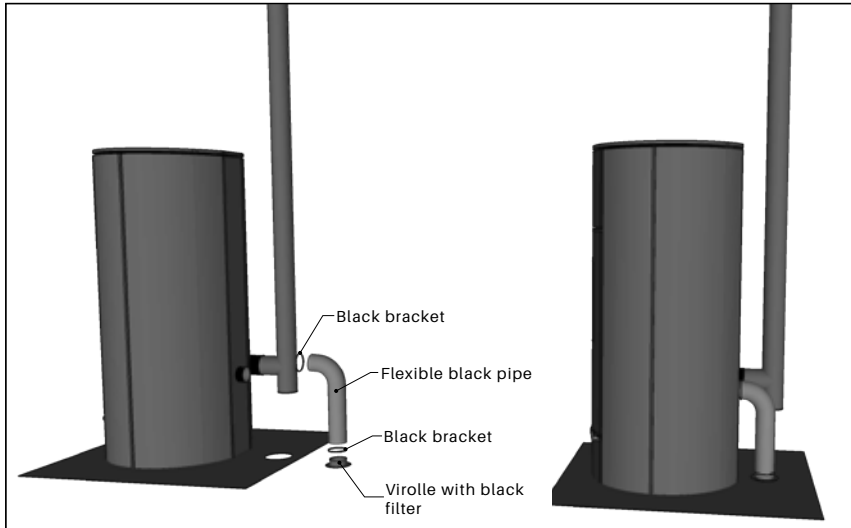

| REF         | DESCRIPTION                           | MOQ |
|-------------|---------------------------------------|-----|
| KFLEXSOL60  | AIR FRESH KIT Ø 60 FOR FLOOR          | 10  |
| KFLEXSOL80  | AIR FRESH KIT Ø 80 FOR FLOOR          | 10  |
| KFLEXSOL100 | AIR FRESH KIT Ø 100 FOR FLOOR         | 10  |
| KFLEXSOL125 | AIR FRESH KIT Ø 125 FOR FLOOR         | 10  |
| AIR10040    | STEP REDUCTION 107 INT. 79-59-39 EXT. | 10  |

# PERFORMANCE KIT

## + PRODUCTS



OPTIONAL  
MULTI Ø 40-60-80-100 MM



100% flexible  
for any difficult connection



Economical ! One product for  
your use no waiting time and always  
in stock



## CHARACTERISTICS

- ✓ Diam. 60, 80, 100 and 125 mm according to model
- ✓ Flexible M1 black on metal frame extendable to 1 m
- ✓ External vent alu cream (RAL 9001)
- ✓ Delivered as a kit in an individual packaging

| REF       | DESCRIPTION                           | MOQ |
|-----------|---------------------------------------|-----|
| KFLEX60   | AIR FRESH KIT Ø 60                    | 10  |
| KFLEX80   | AIR FRESH KIT Ø 80                    | 10  |
| KFLEX100  | AIR FRESH KIT Ø 100                   | 10  |
| KFLEX125  | AIR FRESH KIT Ø 125                   | 10  |
| AIR 10040 | STEP REDUCTION 107 INT. 79-59-39 EXT. | 10  |

Closable version, add V at the end of the reference

**+ PRODUCTS**



OPTIONAL  
MULTI Ø 40-60-80-100 MM



100% flexible  
for any difficult connection



Economical! One product for  
your use no waiting time and always  
in stock

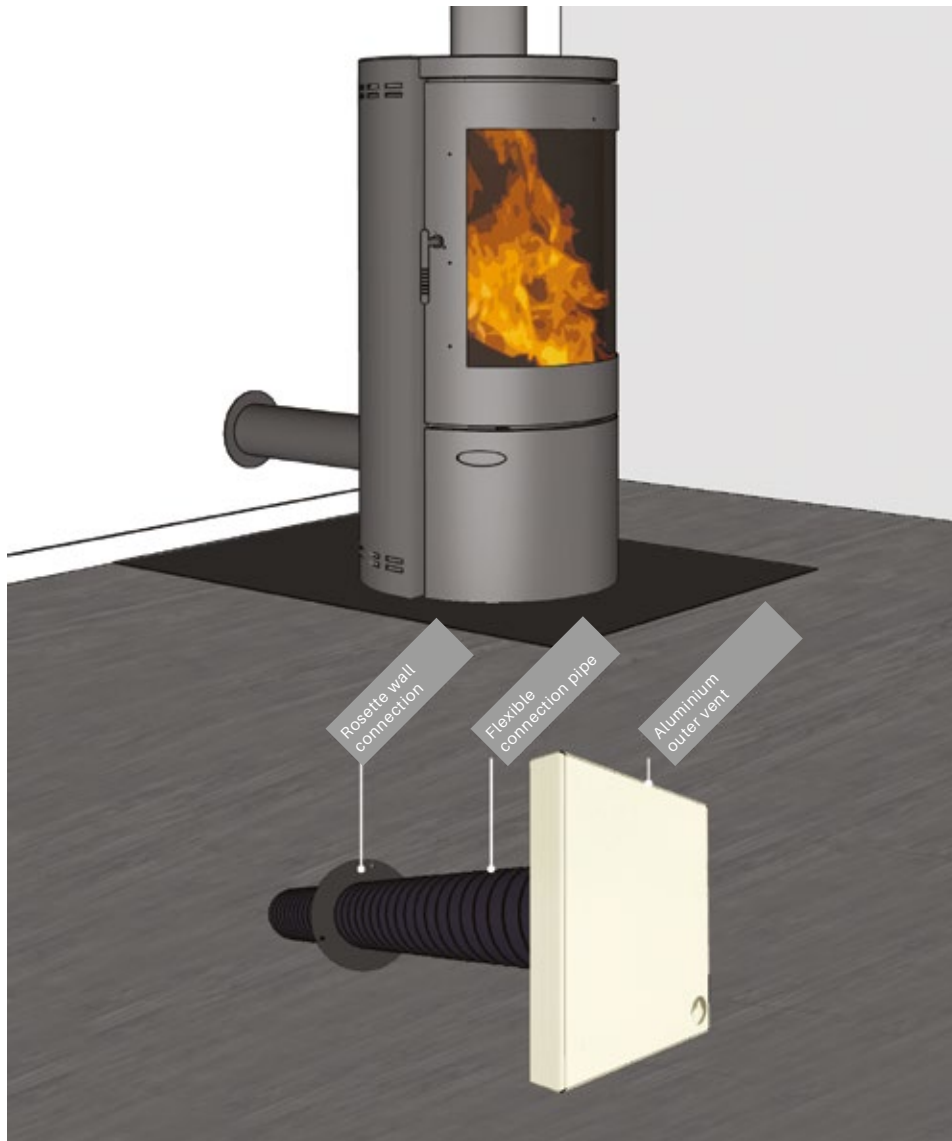

**CHARACTERISTICS**

- ✓ Diam. 60, 80, 100 and 125 mm according to model
- ✓ Flexible M1 black on metal frame extendable to 1 m
- ✓ External vent alu cream (RAL 9001)
- ✓ Delivered as a kit in an individual packaging

| REF          | DESCRIPTION                           | MOQ |
|--------------|---------------------------------------|-----|
| KFLEXARCHI60 | AIR FRESH KIT Ø 60                    | 10  |
| KFLEXARCHI80 | AIR FRESH KIT Ø 80                    | 10  |
| KFLEXARCH100 | AIR FRESH KIT Ø 100                   | 10  |
| KFLEXARCH125 | AIR FRESH KIT Ø 125                   | 10  |
| AIR 10040    | STEP REDUCTION 107 INT. 79-59-39 EXT. | 10  |

Closable version, add V at the end of the reference

# UNIVERSAL KIT (WOOD - PELLETS)

## + PRODUCTS



Multi Ø 40-60-80-100 mm



100% flexible  
for any difficult connection



100% BBC & anti-condensation  
with gasket & insulating sheath



Simple installation  
with wide edges vents  
and double insertion rosette



Economical! One product for  
your use no waiting time and always  
in stock

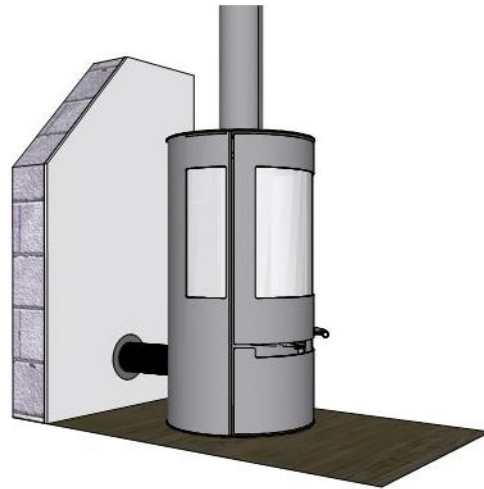

## CHARACTERISTICS

- ✓ Reduction multi-diameters 40-60-80-100
- ✓ Flexible wall leadthrough extends to 50 cm
- ✓ PVC external vent with wide edges
- ✓ Delivered as a kit in an individual packaging

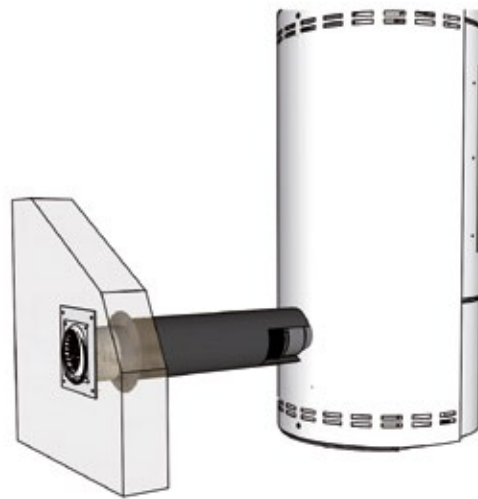

| REF      | DESCRIPTION                                      | MOQ |
|----------|--|-----|
| RDP40100 | UNIVERSAL AIR TIGHT FRESH AIR KIT Ø 100 TO 40 mm | 10  |



| REF       | DESCRIPTION  |
|-----------|--|
| RDPV40100 | UNIVERSAL AIR TIGHT FRESH AIR KIT<br>Ø 100 TO 40 MM CLOSABLE |



# A L U M I N I U M   V E N T   T O   C L I P - O N   O N   H O U S I N G



ANTHRACITE



CREAM

Housing to be fixed   filter   Cream aluminium vent to clip on

| REF       | SIZES     | DIAM. | FINISH | AIRFLOW (FILTER/OPTIONAL) | MOQ |
|-----------|-----------|-------|--------|---------------------------|-----|
| GEALL60C  | 200 x 200 | 60    | CREAM  | 26 cm <sup>2</sup>        | 10  |
| GEALL80C  | 200 x 200 | 80    | CREAM  | 48 cm <sup>2</sup>        | 10  |
| GEALL100C | 200 x 200 | 100   | CREAM  | 96 cm <sup>2</sup>        | 10  |
| GEALL125C | 200 x 200 | 125   | CREAM  | 120 cm <sup>2</sup>       | 10  |
| GEALL150C | 200 x 200 | 150   | CREAM  | 174 cm <sup>2</sup>       | 10  |
| GEALL160C | 200 x 200 | 160   | CREAM  | 180 cm <sup>2</sup>       | 10  |

ANTHRACITE 7016 ON REQUEST



| REF       | SIZES     | DIAM.   | FINISH | AIRFLOW             | MOQ |
|-----------|-----------|---------|--------|---------------------|-----|
| GEADBA150 | 400 x 200 | 2 x 150 | CREAM  | 200 cm <sup>2</sup> | 1   |

# OUTDOOR VENTS ARCHITECTURE AIR FRESH RANGE

Patented model



WALL PART TO BE FIXED  
WITH ANTI-RODENT MESH



REMOVABLE COVER  
ALU LACQUERED CREAM

| REF.     | DESCRIPTION                    | SIZES | SIZES EXT. | AIRFLOW             | MOQ |
|----------|--------------------------------|-------|------------|---------------------|-----|
| GEAA60C  | EXTERNAL VENT ALU CREAM COLOUR | Ø 60  | 200 x 200  | 26 cm <sup>2</sup>  | 10  |
| GEAA80C  | EXTERNAL VENT ALU CREAM COLOUR | Ø 80  | 200 x 200  | 48 cm <sup>2</sup>  | 10  |
| GEAA100C | EXTERNAL VENT ALU CREAM COLOUR | Ø 100 | 200 x 200  | 96 cm <sup>2</sup>  | 10  |
| GEAA125C | EXTERNAL VENT ALU CREAM COLOUR | Ø 125 | 200 x 200  | 120 cm <sup>2</sup> | 10  |
| GEAA150C | EXTERNAL VENT ALU CREAM COLOUR | Ø 150 | 200 x 200  | 174 cm <sup>2</sup> | 10  |
| GEAA160C | EXTERNAL VENT ALU CREAM COLOUR | Ø 160 | 200 x 200  | 180 cm <sup>2</sup> | 10  |



**YOUR  
LOGO  
HERE**

(ON REQUEST)

# OUTDOOR AND SPECIFIC VENTS

## FILLING SLEEVES, REMOTE CONTROL BY CABLE



in galvanised STEEL  
with remote control  
length = 1.50 m

### CHARACTERISTICS

✓ Control button in polished stainless steel

| REF   | DESCRIPTION    | SIZES | AIRFLOW             |
|-------|----------------|-------|---------------------|
| M0100 | FILLING SLEEVE | Ø 100 | 78 cm <sup>2</sup>  |
| M0125 | FILLING SLEEVE | Ø 125 | 132 cm <sup>2</sup> |
| M0150 | FILLING SLEEVE | Ø 150 | 176 cm <sup>2</sup> |
| M0160 | FILLING SLEEVE | Ø 160 | 201 cm <sup>2</sup> |
| M0200 | FILLING SLEEVE | Ø 200 | 314 cm <sup>2</sup> |

## FLEXIBLE ALUMINIUM HOSE 3 METERS STRETCHABLE

| REF       | DESCRIPTION                  | SIZES |
|-----------|------------------------------|-------|
| FLEXA80   | 3 METER LONG «FLEXALU» PIECE | Ø 80  |
| FLEXA100  | 3 METER LONG «FLEXALU» PIECE | Ø 100 |
| FLEXA125  | 3 METER LONG «FLEXALU» PIECE | Ø 125 |
| FLEXA150  | 3 METER LONG «FLEXALU» PIECE | Ø 150 |
| FLEXA160  | 3 METER LONG «FLEXALU» PIECE | Ø 160 |
| FLEXA200  | 3 METER LONG «FLEXALU» PIECE | Ø 200 |
| FLEXA60N  | 3 METER LONG «FLEXALU» PIECE | Ø 60  |
| FLEXA80N  | 3 METER LONG «FLEXALU» PIECE | Ø 80  |
| FLEXA100N | 3 METER LONG «FLEXALU» PIECE | Ø 100 |



Delivered compressed Length =  
0,85 m stretchable to 3 m



Black finishing

## BLANCK INSULATED SHEATH

| REF          | SIZES     | FINISH              |
|--------------|-----------|---------------------|
| FLEXISOL60N  | Ø 60 INT  | BLACK PVC EXT & INT |
| FLEXISOL80N  | Ø 82 INT  | BLACK PVC EXT & INT |
| FLEXISOL100N | Ø 102 INT | BLACK PVC EXT & INT |
| FLEXISOL125N | Ø 127 INT | BLACK PVC EXT & INT |



Black flexible hose

# REMOTE CLOSURE KITS

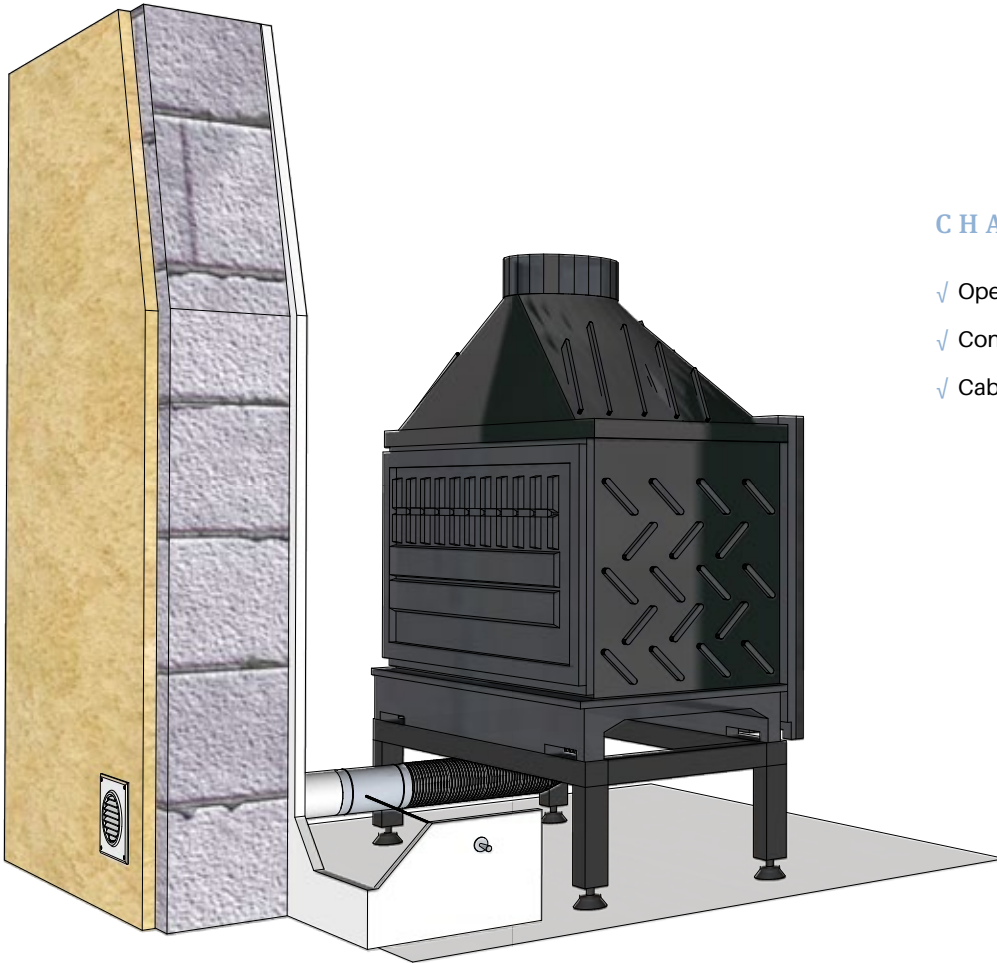

## CHARACTERISTICS

- ✓ Opening and closing from inside the house
- ✓ Control button + stainless steel cable
- ✓ Cable length 1,50 m



| REF  | DESCRIPTION                               | SIZES | MOQ |
|------|---|-------|-----|
| K125 | AIR INLET KIT, CAN BE SHUT OFF AIRTIGHTLY | Ø 125 | 1   |
| K150 | AIR INLET KIT, CAN BE SHUT OFF AIRTIGHTLY | Ø 150 | 1   |
| K160 | AIR INLET KIT, CAN BE SHUT OFF AIRTIGHTLY | Ø 160 | 1   |

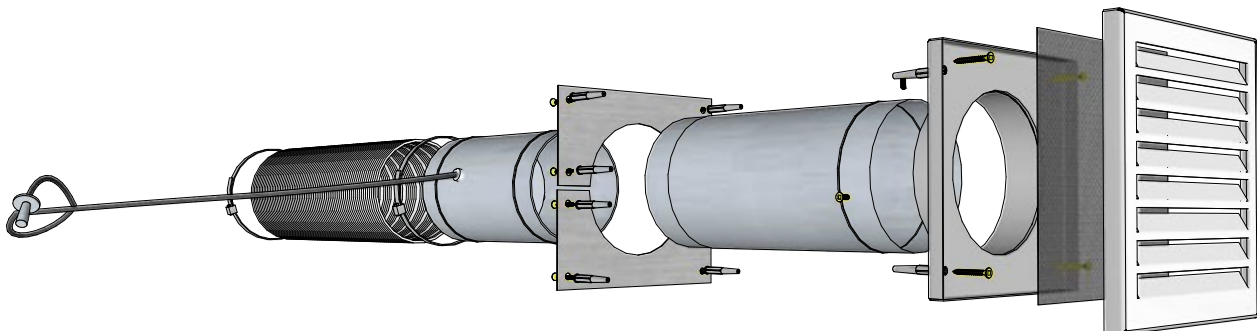







Patented model

THE HEAT SHIELD PROTECTS THE WALLS FROM HIGH TEMPERATURES AND BLACKENING.



Technical notice 14/11 - 1671



### CHARACTERISTICS

- ✓ Allows to divide by 2 the distance from the stove and the pipe to the combustible materials in the low limit of 10 cm for the stove and 20 cm for the pipe
- ✓ Anti-blackening : protects the wall from charring dust
- ✓ Prevents the need to remove flammable wall materials and then paint
- ✓ Easy to maintain
- ✓ Colours : sandblasted black or customized colour
- ✓ To be installed by a professional, read the instructions before installation

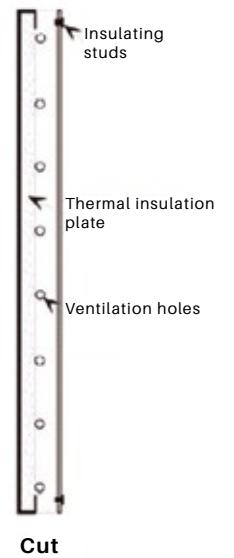

PANISOL RANGE

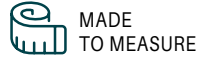

ORDOS SMALL MODEL

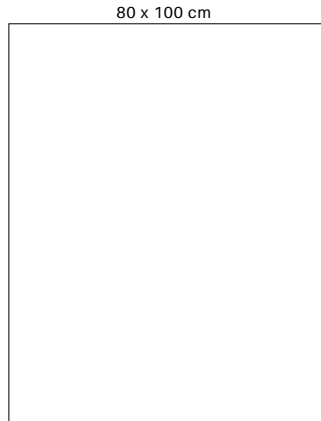

ORDOS  
80 x 120 cm

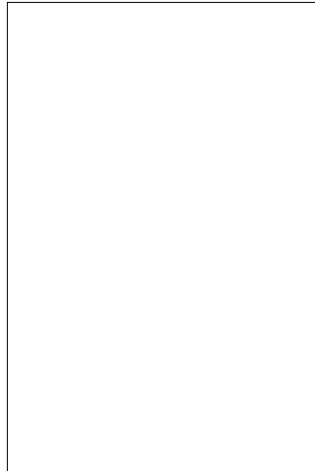

ORDOS FRESH AIR  
80 x 120 cm

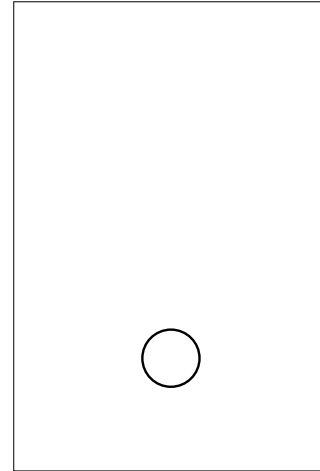

OKLAHOMA  
80 x 120 cm

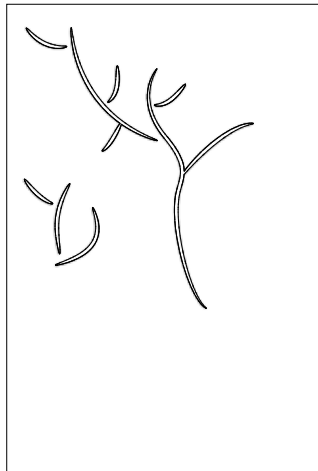

OXFORD  
80 x 120 cm

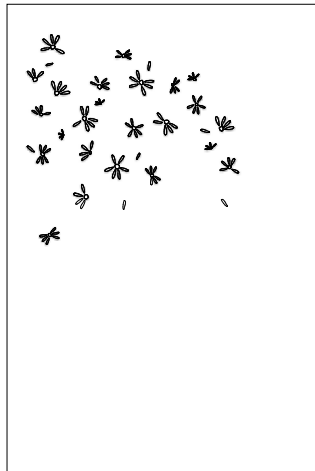

JUNGLE **NEW**  
80 x 120 cm



SIMPLICITY G  
80 x 120 cm

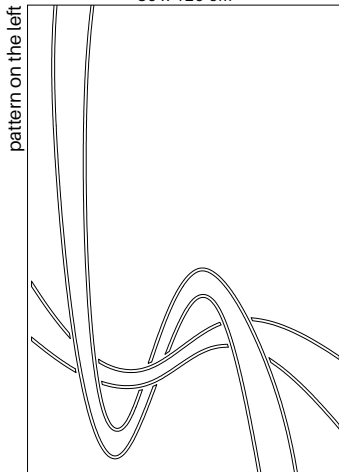

SIMPLICITY D  
80 x 120 cm

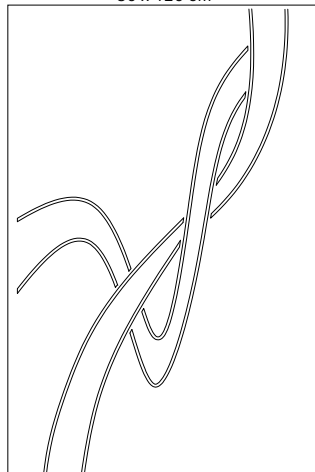

PULSO' PLAK  
80 x 120 cm

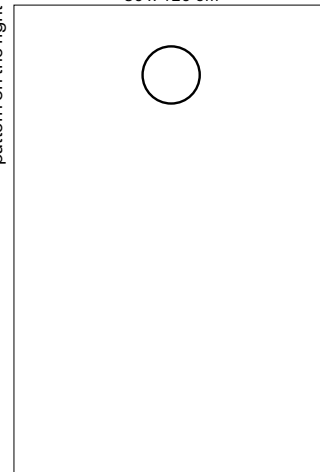

STANDARD COLOUR BLACK SANDBLASTED, OPTIONAL COLOUR



## O R D O S

| REF   | DESCRIPTION  |
|-------|--|
| ORDOS | PANISOL DECOR 80 x 120 cm<br>BLACK SANDBLASTED<br>DIMENSIONS AND COLOURS<br>CAN BE MADE TO MEASURE |



## J U N G L E

REF

DESCRIPTION

JUNGLE

PANISOL DECOR 80 x 120 cm  
BLACK SANDBLASTED  
DIMENSIONS AND COLOURS  
CAN BE MADE TO MEASURE



# O K L A H O M A

| REF      | DESCRIPTION  |
|----------|--|
| OKLAHOMA | PANISOL DECOR 80 x 120 cm<br>BLACK SANDBLASTED<br>DIMENSIONS AND COLOURS<br>CAN BE MADE TO MEASURE |



Log holder (see p.124)



## O X F O R D

| REF    | DESCRIPTION  |
|--------|--|
| OXFORD | PANISOL DECOR 80 x 120 cm<br>BLACK SANDBLASTED<br>DIMENSIONS AND COLOURS<br>CAN BE MADE TO MEASURE |

Model presented in White with option  
OC30 white colour



Pellets holder (see p.121)

## S I M P L I C I T Y

| REF     | DESCRIPTION                                      |
|---------|--|
| SIMPL-G | PANISOL DECOR 80 X 120 CM BLACK SANDBLASTED      |
| SIMPL-D | PANISOL DECOR 80 X 120 CM BLACK SANDBLASTED      |
|         | DIMENSIONS AND COLOURS<br>CAN BE MADE TO MEASURE |

pattern on the left





**+ PRODUCTS**

- + Prevents heat build-up on the ceiling
- + Promotes thermal exchange in the room
- + Gives a pulsating effect like a pellet stove
- + Automatically triggers at 40°
- + Electrical connection by thermally insulated cable
- + Discreet and integrated unit

| REF        | DESCRIPTION  |
|------------|--|
| PULSOPLACK | PANISOL DECOR 80 X 120 CM<br>BLACK SANDBLASTED<br>DIMENSIONS AND COLOURS<br>CAN BE MADE TO MEASURE |



# CLADDING FOR CEILING CONNECTIONS FOR INSULATED DUCTS



| REF      | DESCRIPTION     |               |       |
|----------|-----------------|---------------|-------|
| HRPR120B | Ø 125 TO 230 mm | HEIGHT 120 mm | WHITE |
| HRPR120N | Ø 125 TO 230 mm | HEIGHT 120 mm | BLACK |
| HRPR200B | Ø 125 TO 230 mm | HEIGHT 200 mm | WHITE |
| HRPR200N | Ø 125 TO 230 mm | HEIGHT 200 mm | BLACK |
| HRPP120B | Ø 80 TO 125 mm  | HEIGHT 120 mm | WHITE |
| HRPP120N | Ø 80 TO 125 mm  | HEIGHT 120 mm | BLACK |

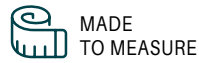

ONE-PIECE MODEL

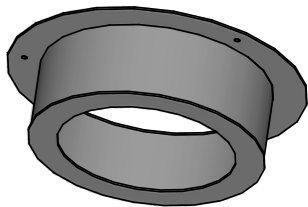

FLAT AND ARCHED MODELS

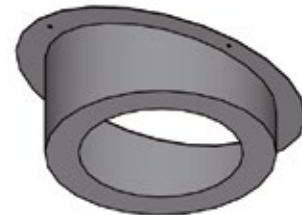

ARCHED MODEL

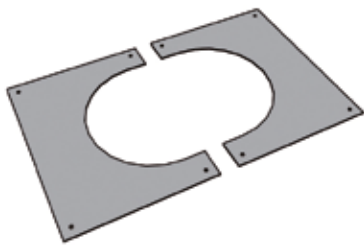



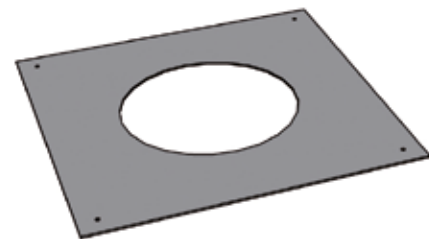
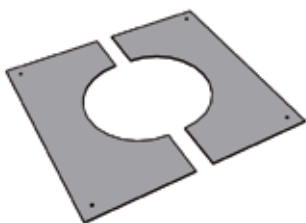



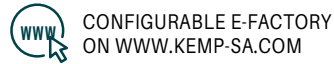
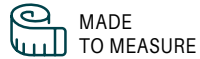





MODEL FOR FLAT CEILINGS



# FLOOR PROTECTION PLATES



| DESIGN  | REF       | DESCRIPTION  |
|---|-----------|--|
|    | 80100N    | BLACK SANDBLASTED STEEL PLATE<br>800 X 1000 MM                   |
|    | 120100I   | STAINLESS STEEL PLATE 1200 X 1000 MM                             |
|    | 80N       | BLACK SANDBLASTED STEEL PLATE<br>Ø 800 MM                        |
|    | 100100GN  | BLACK SANDBLASTED STEEL PLATE<br>1000 X 1000 MM                  |
|  | 120100RN  | BLACK SANDBLASTED STEEL PLATE<br>ROUNDED IN FRONT 1200 X 1000 MM |
|  | 80100RN   | BLACK SANDBLASTED STEEL PLATE<br>ROUNDED IN FRONT 800 X 1000 mm  |
|  | 100100AN  | BLACK SANDBLASTED STEEL ANGLE PLATE<br>ROUNDED 1000 X 1000       |
|  | 80100I    | STAINLESS STEEL PLATE 800 X 1000 MM                              |
|  | 80I       | STAINLESS STEEL PLATE Ø 800 MM                                   |
|  | 1106EV    | GLASS PLATE 1100 X 1100 MM                                       |
|  | 85110RV   | GLASS PLATE<br>ROUNDED IN FRONT 850 X 1100 MM                    |
|  | 120105RCV | GLASS PLATE 1050 X 1200 MM                                       |

## CHARACTERISTICS

- ✓ Sandblasted black lacquered steel plate th.2
- ✓ Stain stainless steel plate th. 2
- ✓ Glass plate flat polished gaskets th. 8
- ✓ Made to measure : contact us



Rectangular plate stainless steel



Round black sandblasted plate



Wood stove Chamane / Invicta / Design : B.Dequet





**B5PMN** Black

**CHARACTERISTICS**

- ✓ Metal barrier for children and pets protection
- ✓ Special mesh to increase transparency at 1 m from the ground for better fire viewing
- ✓ Moderate temperature handling grips for easy filling

5-piece monobloc format :

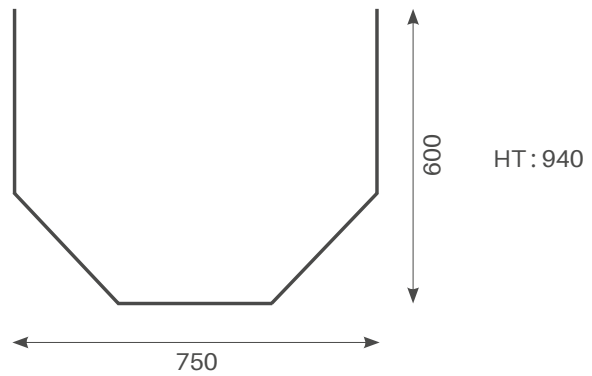

**B5PMB** CUSTOMIZED PAINTING ON REQUEST

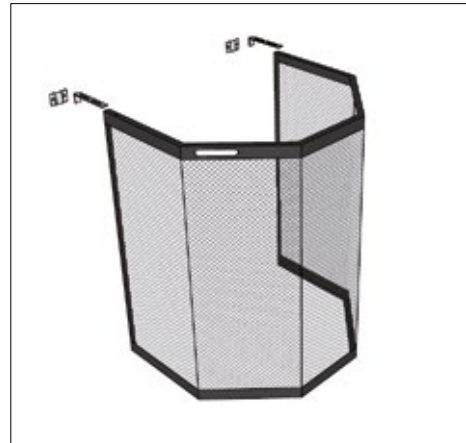

WALL MOUNTING SYSTEM

| REF   | DESCRIPTION   |
|-------|---|
| B5PMN | PROTECTIVE BARRIER 5-PIECE MONOBLOC FORMAT BLACK SANDBLASTED FINISHING<br>FORMAT 750 X 600 mm |

## A C C E S S   D O O R S   3 0   X   3 0



| REF  | DESCRIPTION                                  | MOQ |
|------|--|-----|
| V30B | ACCESS DOORS 30 X 30 CM WHITE WITH PRE-FRAME | 10  |
| V30N | ACCESS DOORS 30 X 30 CM BLACK WITH PRE-FRAME | 10  |

## T E C H N I C A L   A C C E S S   D O O R



### CHARACTERISTICS

- ✓ Reversible door with steel frame
- ✓ Dimensions : 567 x 567 and 567 x 1484 mm ext. Including frame
- ✓ Lacquered finishing

| REF        | DESCRIPTION                                    |
|------------|--|
| VPELLETS   | ACCESS DOOR 67 x 1484 mm FOR PELLETS FIREPLACE |
| VPELLETSPM | ACCESS DOOR 567 x 567 mm FOR PELLETS FIREPLACE |



**3535TRAPB:**  
VENTILATION + TECHNICAL ACCESS  
FOR GAS/PELLETS FIREPLACE  
(see p.61)

S T A I N L E S S   S T E E L   C L E A N I N G   P R O T E C T I O N   P L A T E

**NEW**



Ideal for cleaning the brazier of pellet stoves without dirtying the floor

| REF  | DESCRIPTION                                   |
|------|---|
| PPNI | CLEANING PROTECTION PLATE Ø 300 MM CUT 250 mm |

P E L L E T   F I L T E R   P A N



| REF    | DESCRIPTION              |
|--------|--------------------------|
| PELLE1 | PELLET FILTER PAN BLACK  |
| OC30   | COLOUR OPTION MINIMUM 10 |



DECO TOOL STORAGE

COLOURS : BLACK, WHITE

A T O L E



REF  
SERVATOLE N OR B  
Ø 17 x H 43 cm



SOLID STEEL TOOL STORAGE



**ÉTOILE**  
COLOURS : BLACK, WHITE

| REF    | DIMENSIONS        |
|--------|-------------------|
| ÉTOILE | 22 x H 64 x 10 cm |
| OC30   | COLOUR OPTION     |

CLASSIC & ECONOMICAL TOOL STORAGE  
COLOUR: BLACK

SAINT-LOUIS



| REF        | DIMENSIONS        |
|------------|-------------------|
| SAINTLOUIS | 25 x H 70 x 25 cm |

GEORGES V



| REF      | DIMENSIONS        |
|----------|-------------------|
| GEORGESV | 20 x H 70 x 20 cm |

SMALL TOOL STORAGE



| REF       | DIMENSIONS        |
|-----------|-------------------|
| SERVPM1   | 15 x H 35 x 20 cm |
| BROSSEPM1 | H 30 x 12 cm      |
| PELLEPM1  | H 30 x 12 cm      |

PELLET DISPENSER OPÉRA



WHITE METALLIC



ANTHRACITE GREY METALLIC RAL 7015



BLACK METALLIC



**+ PRODUCT**

- + Contains 30 kg of pellets
- + Filling hatch for handling a 5 kg bucket
- + Wood dust filter at the bottom of the bucket

DIMENSIONS DIAM.40 X H95CM

| REF    | DESCRIPTION                      |
|--------|----------------------------------|
| OPERAB | PELLET DISPENSER WHITE           |
| OPERAG | PELLET DISPENSER ANTHRACITE GREY |
| OPERAN | PELLET DISPENSER BLACK           |

design



# EIFFEL PELLETS STORAGE



| REF      | DESCRIPTION                   |
|----------|-------------------------------|
| EIFFELPM | WOODEN TRAY 35 x H 55 x 21 cm |
| EIFFELGM | WOODEN TRAY 40 x H 45 x 40 cm |

Wooden tray in Scots pine





# ODÉON

COLOURS : WHITE - COVER WHITE, COPPER OR WOOD

MULTI-FUNCTION

ON CASTORS



| REF         | DIMENSIONS                    |
|-------------|-------------------------------|
| ODEONWHITE  | WHITE TRAY 40 x H 40 x 40 cm  |
| ODEONCUIVRE | COPPER TRAY 40 x H 40 x 40 cm |
| ODEONBOIS   | WOODEN TRAY 40 x H 40 x 40 cm |

Capacity 1 bag of 15 kg



MIXED STORAGE



**CAPUCINES**  
COLOURS: BLACK, WHITE

 ON CASTORS



**REF**  
**CAPUCINES N OR B**  
40 x H 110 x 60 cm



**L O U V R E**

COLOURS : BLACK, WHITE

MULTI-FUNCTION



| REF           | DIMENSIONS        |
|---------------|-------------------|
| LOUVRE N OR B | 40 x H 40 x 35 cm |



**S K A T E**

COLOUR : BLACK

| REF   | DIMENSIONS        |
|-------|-------------------|
| SKATE | 65 x H 30 x 35 cm |

Oblica desgin

# ÉLYSÉE

COLOURS: BLACK, WHITE



| REF            | DESCRIPTION   | DIMENSIONS        |
|----------------|---------------|-------------------|
| ELYSEPM N OR B | LOGS OF 30 cm | 45 x H 35 x 35 cm |
| ELYSEGM N OR B | LOGS OF 50 cm | 60 x H 47 x 50 cm |



# SAINT - HONORÉ

COLOURS: BLACK AND WHITE ON STOCK

MULTI-FUNCTION

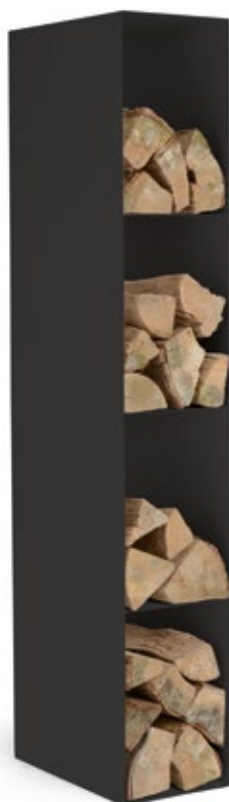

| REF         | DIMENSIONS         |
|-------------|--------------------|
| SAINTHONORE | 20 x H 120 x 33 cm |
| 0G30        | COLOUR OPTION      |



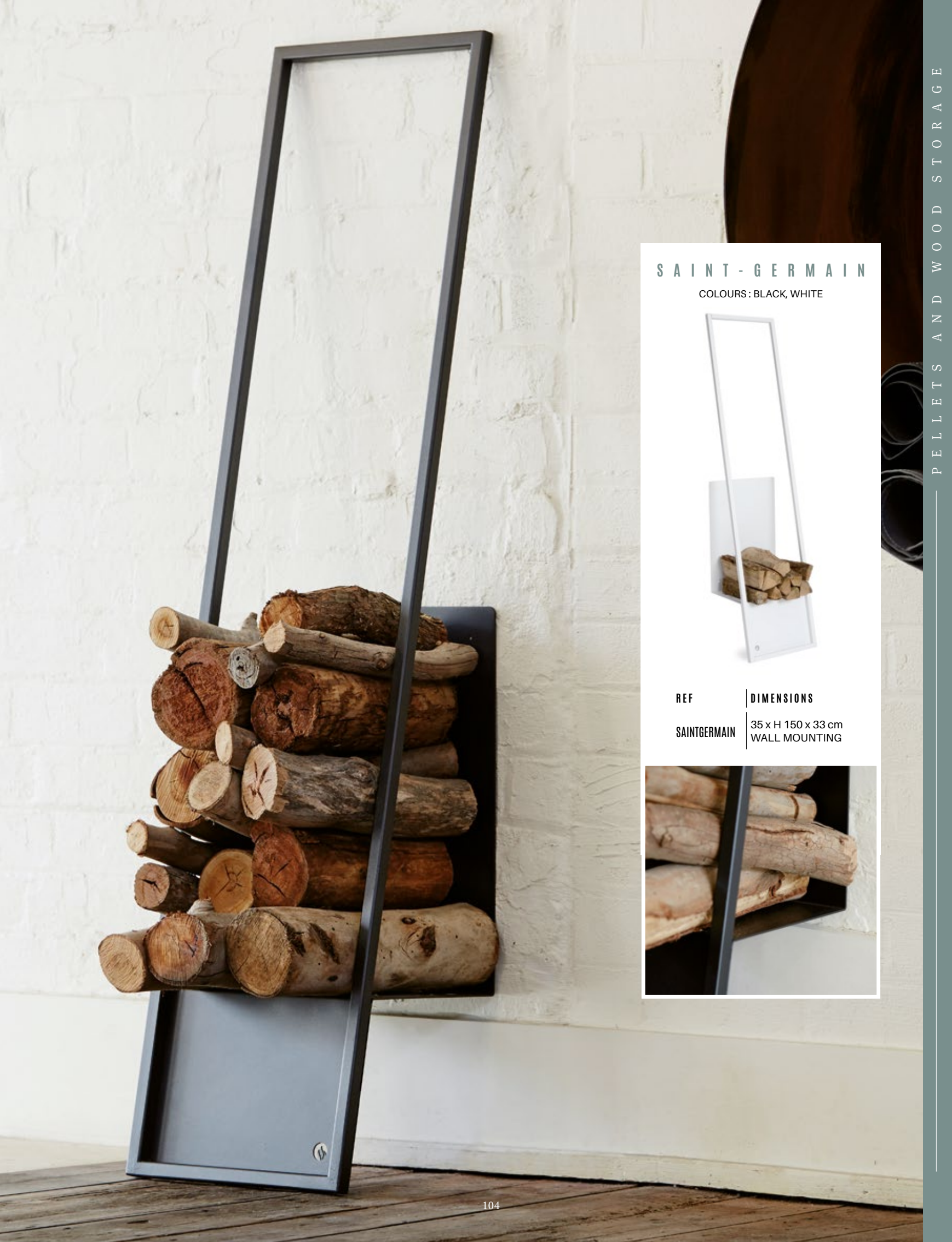

SAINT - GERMAIN

COLOURS : BLACK, WHITE



REF

DIMENSIONS

SAINTGERMAIN

35 x H 150 x 33 cm  
WALL MOUNTING



# T I P I

COLOURS : BLACK, WHITE



REF

DIMENSIONS

TIPI PM N OR B 65 x H 65 x 35 cm

TIPI GM N OR B 50 x H 100 x 30 cm





**S E I N E**

COLOURS : BLACK, WHITE



| REF          | DIMENSIONS         |
|--------------|--------------------|
| SEINE N OR B | 31 x H 130 x 35 cm |

**B A B Y L O N E**

COLOURS : BLACK, WHITE



| REF                | DIMENSIONS          |
|--------------------|---------------------|
| BABYLONE N OR B    | 100 x H 160 x 25 cm |
| BABYLONE GM N OR B | 100 x H 160 x 40 cm |

**V E N D Ô M E**

COLOURS : BLACK, WHITE

MULTI-FUNCTION



| REF            | DIMENSIONS         |
|----------------|--------------------|
| VENDOME N OR B | 41 x H 130 x 35 cm |



O H !

COLOUR: BLACK

| REF | DESCRIPTION | DIMENSIONS     |
|-----|-------------|----------------|
| OH  | WOOD BOX    | Ø 60 x D 35 cm |

Oblica desgin



## B I G ' O

COLOURS : BLACK, WHITE

| REF   | DESCRIPTION | SIZES          |
|-------|-------------|----------------|
| BIG.0 | WOOD BOX    | Ø 95 x D 40 cm |

Oblica desgin



# W O O D B O X

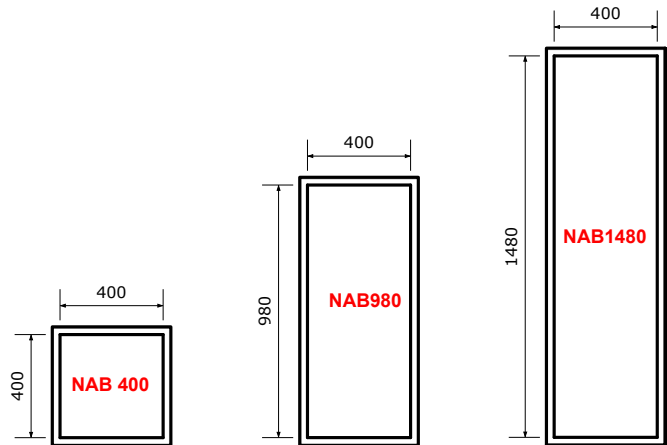
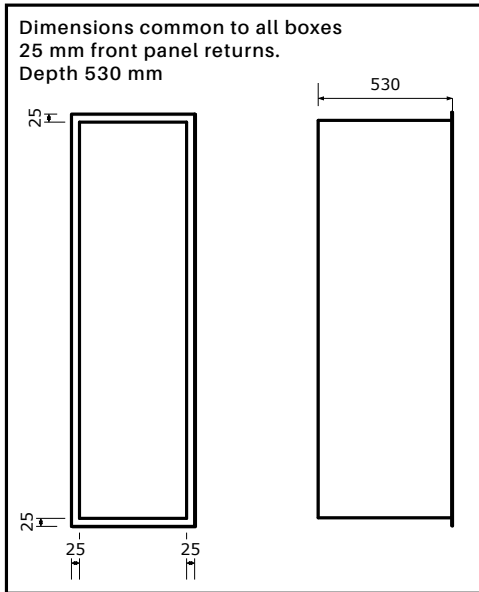
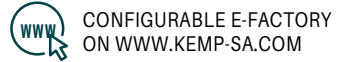
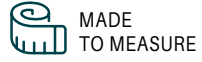

| REF             | DESCRIPTION                                   | SIZES      |
|-----------------|---|------------|
| NAB400          | WOOD BOX                                      | 400 x 400  |
| NAB980          | WOOD BOX                                      | 980 x 400  |
| NAB1480         | WOOD BOX                                      | 1480 x 400 |
| MADE TO MEASURE | CUSTOMIZED WOOD BOX                           |            |
| OE              | SHELF OPTION                                  |            |
| OSL             | OPTION : CUT-OUT FOR SPOTLIGHT (not supplied) | Ø 65       |
| OC30            | COLOUR OPTION                                 |            |
| OT              | DRAWER OPTION                                 |            |

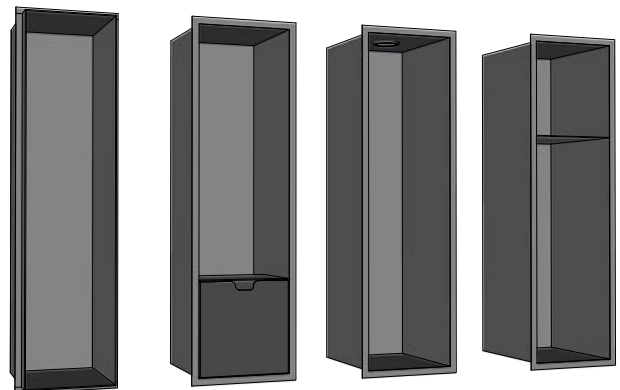

OPTIONAL SHELF / HOLES FOR SPOTLIGHT / DRAWER: CONTACT US

W O O D B O X



1480 STANDARD WOOD BOX WITH DRAWER OPTION  
MADE TO ORDER

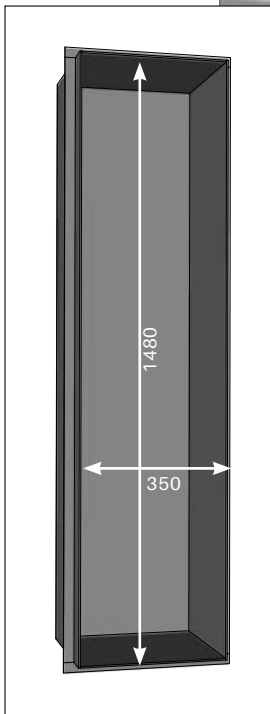

NEW DESIGN WOOD BOX  
By protruding 10 cm beyond the formwork, NABPRO1480 allows the formwork depth to be reduced.

| REF        | SIZES                           |
|------------|---------------------------------|
| NABPRO1480 | H 1480 mm x L 350 mm x D 530 mm |

W O O D B O X B E E H I V E

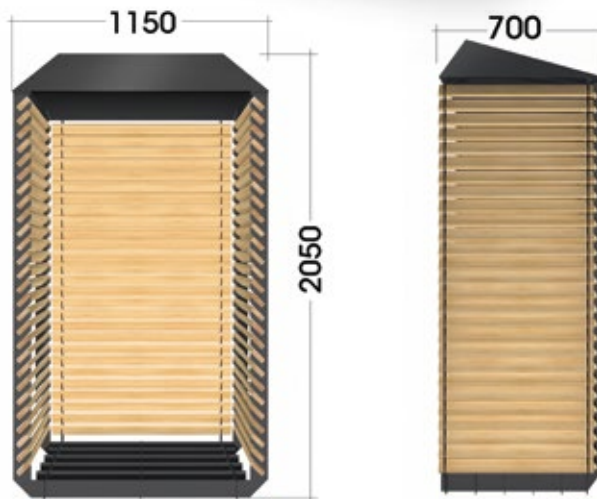

Joseph Heissat design

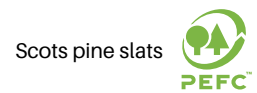

| REF     | DESCRIPTION                                  | FINISH   |
|---------|--|--|
| BEEHIVE | OUTDOOR WOOD STORAGE H 205 X L 115 X D 70 cm | UNTREATED PINE TO BE STAINED - SANDBLASTED BLACK METAL STRUCTURE |



# LOG SWING



Joseph Heissat design

| REF       | DESCRIPTION   |
|-----------|---|
| BAB5030 G | LOG SWING 500 X 300 mm GREY LAQUERED STAINLESS STEEL CABLES |

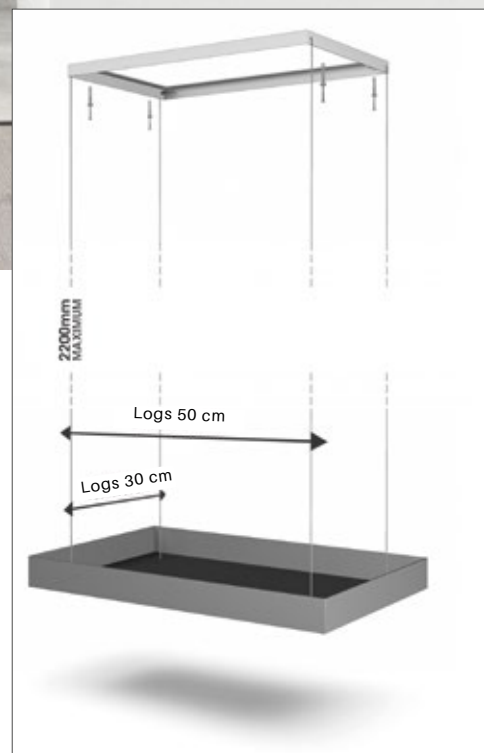

TOOL STORAGE "UP ON A TREE"



Joseph Heissat design

| REF               | DESCRIPTION   |
|-------------------|---|
| SERVHDSA RAL.XXXX | STAINLESS TREE 4-PIECE PEDESTAL FOR FIRE TOOLS STORAGE 3 SECTIONS TO ATTACH TO FIREPLACE UNIT |



MIRROR POLISHED  
STAINLESS STEEL

RAL.3027

RAL.7036

RAL.1019

RAL.7033

RAL.9005

RAL.9016



# G A S B O T T L E C O V E R

NEW



## + PRODUCT

- + Quick assembly
- + Hides the view of the bottles
- + Protects the installation

| REF  | DESCRIPTION      | SIZES                  |
|------|------------------|------------------------|
| CBDG | GAS BOTTLE COVER | H 1570 X L 960 X D 550 |









Simple, efficient, autonomous, wind-operated, Girostop is a dynamic rain protection and smoke evacuation system.

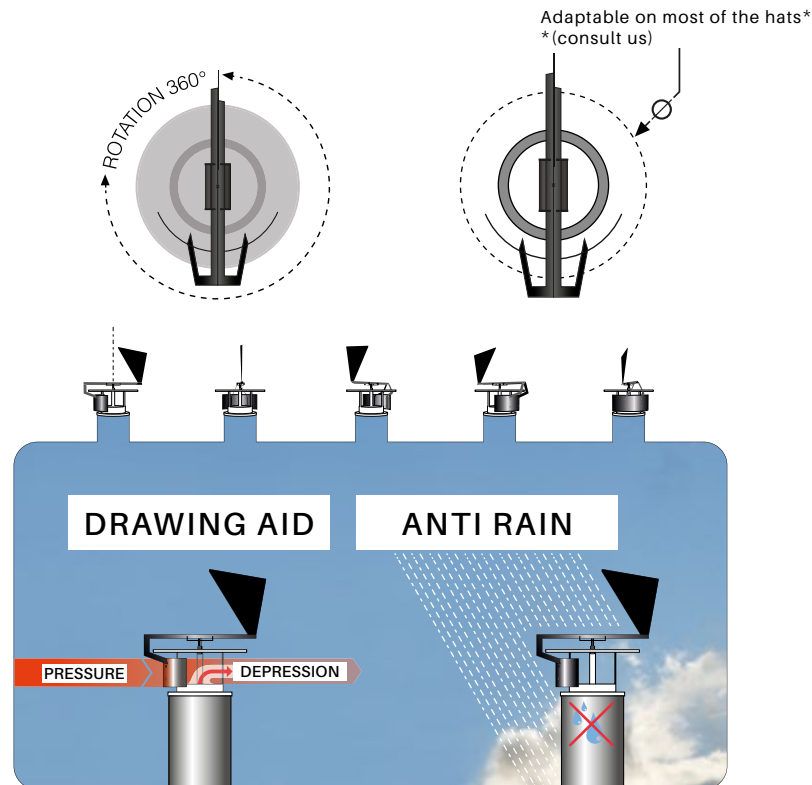

Patent n°1001160 - Design & Concept Gilles Heissat ©.

TO ORDER YOUR GIROSTOP ACCORDING TO THE BRAND AND THE DIAMETER OF THE PIPE

| Ref. GIR       | XXX | DDD   |
|----------------|-----|-------|
| Poujoulat      | PJL | Diam. |
| Isotip-Joncoux | JCX | Pipe  |
| Modinox        | MDX |       |
| Ten            | TEN |       |

Hat not provided, only Girostop  
To order, please ask for the quotation form

WATCH THE INSTALLATION DEMONSTRATION ON YOUTUBE

# I N S U L A T I O N

## CALCIUM SILICATE



### CHARACTERISTICS

- ✓ 100% natural insulating panel
- ✓ Classified M0, resistance to more than 1000°.
- ✓ Complies with DTU 24.2
- ✓ No need for metal framing for formwork
- ✓ Easy to cut with a ruler and a circular saw
- ✓ Masonry lining and insulation in one material
- ✓ Installs like plasterboard
- ✓ Lightweight (density 250 kg/m<sup>3</sup>); 1 panel = 13.2 kg



| REF      | DESCRIPTION                        |
|----------|------------------------------------|
| SILI30   | SILICATE PANEL 1220 X 1000 X 30 mm |
| COLLE290 | SILICATE GLUE IN 290 ml CARTRIDGE  |

R O C K W O O L 3 0 M M



| REF | DESCRIPTION                                     |
|-----|---|
| LR  | PLATE 1 M X 0,6 M THICKNESS 30 mm (12 in a box) |

F L E X I B L E I N S U L A T I O N M I N E R A L F I B E R



| REF | DESCRIPTION                     | MOQ        |
|-----|---------------------------------|------------|
| FC  | ROLL WIDTH 1,22 M LENGTH 4,92 m | 6 / PALLET |

H I G H T E M P E R A T U R E A L U M I N I U M A D H E S I V E T A P E

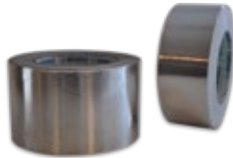

| REF     | DESCRIPTION           | MOQ |
|---------|-----------------------|-----|
| ADHESIF | ROLL 50 m WIDTH 50 mm | 24  |
| ADHES75 | ROLL 50 m WIDTH 75 mm | 16  |

C E R A M I C T H I N I N S U L A T I O N



| REF | DESCRIPTION                         | MOQ |
|-----|-------------------------------------|-----|
| CB  | PLATE 1,2 M X 0,8 m THICKNESS 10 mm | 1   |

B I A F E U



| REF    | DESCRIPTION   | MOQ |
|--------|---------------|-----|
| BIAFEU | 100-LITRE BAG | 1   |



TURBINES SHOULD ALWAYS BE PLACED IN A VENTILATED AREA.  
PRODUCT WITH BUILT-IN THERMAL PROBE.

| REF   | DESCRIPTION   |
|-------|---|
| AE400 | 1-SPEED AIR DISTRIBUTION UNIT (400 m <sup>3</sup> /h WITH Ø 125 NOZZLES) MAX 20 M |
| AE550 | 1-SPEED AIR DISTRIBUTION UNIT (500 m <sup>3</sup> /h WITH Ø 125 NOZZLES) MAX 20 M |

ISOFLEX, CARTON OF 10 METRES

| REF    | DESCRIPTION             | DIMENSIONS |
|--------|-------------------------|------------|
| ISO60  | SOUND INSULATING SHEATH | Ø 60       |
| ISO80  | SOUND INSULATING SHEATH | Ø 80       |
| ISO98  | SOUND INSULATING SHEATH | Ø 100      |
| ISO123 | SOUND INSULATING SHEATH | Ø 125      |
| ISO150 | SOUND INSULATING SHEATH | Ø 150      |

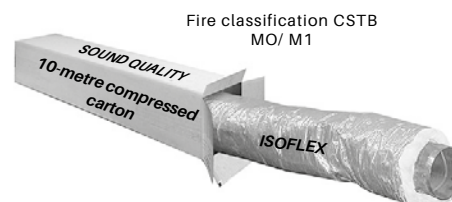



# VENTILATION ACCESSORIES

## CLOVERLEAF SLEEVE FOR FLEXALU OR ISOFLEX DERIVATION



| REF  | DESCRIPTION       | DIMENSIONS | CORRESPONDENCE |
|------|-------------------|------------|----------------|
| T80  | CLOVERLEAF SLEEVE | 3 x Ø 80   | FLEXIBLE 80    |
| T98  | CLOVERLEAF SLEEVE | 3 x Ø 100  | FLEXIBLE 100   |
| T123 | CLOVERLEAF SLEEVE | 3 x Ø 125  | FLEXIBLE 125   |
| T147 | CLOVERLEAF SLEEVE | 3 x Ø 150  | FLEXIBLE 150   |

## UNIVERSAL HOSE CLAMP FOR FLEXIBLE

| REF | DESCRIPTION          | DIMENSIONS       |
|-----|----------------------|------------------|
| S0  | UNIVERSAL HOSE CLAMP | Ø 60 TO 175 MAXI |



With disengageable screw clamp  
Ø 60 TO 175 MAXI

## SINGLE ALUMINIUM HOSE STRETCHABLE TO 3 METRES

| REF       | DESCRIPTION                 | DIMENSIONS |
|-----------|-----------------------------|------------|
| FLEXA80   | LONG FLEXALU PIECE 3 METERS | Ø 80       |
| FLEXA100  | LONG FLEXALU PIECE 3 METERS | Ø 100      |
| FLEXA125  | LONG FLEXALU PIECE 3 METERS | Ø 125      |
| FLEXA150  | LONG FLEXALU PIECE 3 METERS | Ø 150      |
| FLEXA160  | LONG FLEXALU PIECE 3 METERS | Ø 160      |
| FLEXA200  | LONG FLEXALU PIECE 3 METERS | Ø 200      |
| FLEXA60N  | LONG FLEXALU PIECE 3 METERS | Ø 60       |
| FLEXA80N  | LONG FLEXALU PIECE 3 METERS | Ø 80       |
| FLEXA100N | LONG FLEXALU PIECE 3 METERS | Ø 100      |

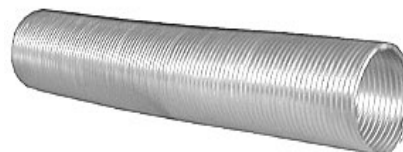

Delivered compressed long =  
0,85 m stretchable to 3 m



Black finishing!

## INSULATED BLACK PIPE

| REF          | SIZES     | FINISH              |
|--------------|-----------|---------------------|
| FLEXISOL60N  | Ø 60 INT  | PVC BLACK EXT & INT |
| FLEXISOL80N  | Ø 82 INT  | PVC BLACK EXT & INT |
| FLEXISOL100N | Ø 102 INT | PVC BLACK EXT & INT |
| FLEXISOL125N | Ø 127 INT | PVC BLACK EXT & INT |



Black flexible

## MALE FITTINGS FOR FLEXALU OR ISOFLEX

| REF   | DESCRIPTION  | DIMENSIONS |
|-------|--------------|------------|
| RM80  | MALE FITTING | Ø 80       |
| RM98  | MALE FITTING | Ø 100      |
| RM123 | MALE FITTING | Ø 125      |
| RM147 | MALE FITTING | Ø 150      |



in aluminium

## ALU REDUCTION FOR FLEXALU OR ISOFLEX

| REF | DESCRIPTION           | DIMENSIONS  |
|-----|-----------------------|-------------|
| R15 | REDUCTION FOR FLEXALU | Ø 80 > 50   |
| R13 | REDUCTION FOR FLEXALU | Ø 80 > 60   |
| R14 | REDUCTION FOR FLEXALU | Ø 100 > 80  |
| R1  | REDUCTION FOR FLEXALU | Ø 124 > 97  |
| R4  | REDUCTION FOR FLEXALU | Ø 150 > 122 |



in aluminium

## HIGH TEMPERATURE GLUE, MASTIC AND SILICONE



CJS



CMR



MR

| REF | DESCRIPTION  | MOQ |
|-----|--|-----|
| CJS | HIGH TEMPERATURE SILICONE CARTRIDGE 310 ML, 150°C RESISTANCE | 6   |
| CMR | REFRACTORY PUTTY CARTRIDGE 310 ML, RESISTANCE TO 1500°C      | 6   |
| MR  | HEAT-RESISTANT PUTTY 450 G JAR                               | 6   |

## S E A L I N G   S Y S T E M

| REF  | DESCRIPTION            | DIMENSIONS |
|------|------------------------|------------|
| TP7  | BLACK ADHESIVE SEALING | 7 x 2.5 m  |
| TP10 | BLACK DRY SEALING      | 10 x 5 m   |
| TP20 | BLACK ADHESIVE SEALING | 20 x 1.2 m |
| TR4  | ROUND BLACK SEALING    | Ø 4        |
| TR6  | ROUND BLACK SEALING    | Ø 6        |
| TR8  | ROUND BLACK SEALING    | Ø 8        |
| TR10 | ROUND BLACK SEALING    | Ø 10       |



FIBER BLACK SEALING

| REF      | DESCRIPTION                              | MOQ |
|----------|--|-----|
| COLLEFEU | TUBE 50 ML OF GLUE, RESISTANCE TO 1100°C | 6   |



COLLEFEU

## H I G H   T E M P E R A T U R E   A E R O S O L   P A I N T



BN

| REF | DESCRIPTION                                | MOQ |
|-----|--|-----|
| BN  | AEROSOL 500 ml BLACK HIGH TEMPERATURE      | 12  |
| BA  | AEROSOL 500 ml ANTHRACITE HIGH TEMPERATURE | 12  |

## MAINTENANCE PRODUCTS



| REF | DESCRIPTION               | VOLUME | MOQ |
|-----|---------------------------|--------|-----|
| KB  | POLISH BOTTLE             | 60 ml  | 12  |
| PF  | GLASS CLEANER FOR INSERTS | 500 ml | 12  |
| NI  | STAINLESS CLEANER         | 300 ml | 12  |

## ASH VACUUM



| REF    | DESCRIPTION  |
|--------|--|
| ASPI12 | COMPACT VACUUM Ø 26 X H 28 cm - 12L - 230V<br>ELECTRIC WIRE = 1,5m PIPE = 1,2m |

## REPLACEMENT OF BROKEN GLASS

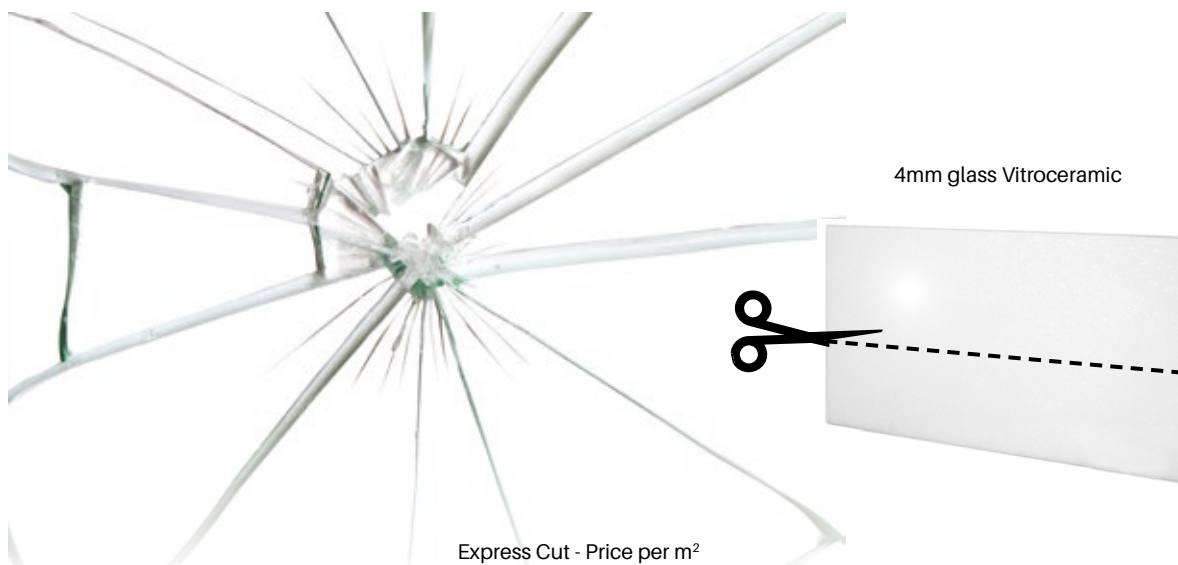



**Standard products  
can be delivered within  
10 BUSINESS DAYS**  
(subject to availability).



**1 YEAR GUARANTEE**



PROHIBITION TO SELL ONLINE WITHOUT RESPECTING THE RRP  
(RECOMMENDED RETAIL PRICES)

#### ART. 1 ORDERS

All orders are subject to these general terms and conditions which take precedence over any other stipulations relevant to the customer's purchase. In addition, the French-language version of these general terms and conditions will prevail over all others. In-person orders or those given over the telephone are only valid after being confirmed by written or faxed purchase order.

Custom orders must also be confirmed with a purchase order, a design sketch and a DEPOSIT of a minimum of 30%. Discounts, rebates or special pricing agreed to when the order is placed are final and definitive under the condition that required payment is made within the agreed-upon deadline. If the conditions of this clause are not met, our invoices will automatically be increased to include the amount of the rebate or discount, using current pricing, and this amount will be invoiced separately. Claims related to manufacturing defects or errors must be brought to our attention within five days from the date the merchandise is delivered.

#### ART. 2 DELIVERY DELAYS

All custom manufacturing as quoted requires a production period of two to six weeks after receipt of the deposit. Our delivery timelines are always estimates. Whatever delivery date is estimated, there will be no indemnity or penalty due in the event that this date is not met, unless we have agreed to such conditions in writing. We will be released from any agreed upon delivery dates in the event of force majeure, such as strikes, lock-outs, delays by our suppliers, fire, etc.

A delay is not sufficient reason to cancel an order, in part or in full.

#### ART. 3 SHIPPING

Orders of more than €700 (pre-tax) are eligible for shipping and packaging fees to be waived within metropolitan France (this applies ONLY to TECH ACCESSOIRES). With regard to metal fireplaces, frames, other types of fireplaces, KIT'FEU products, VITROFLAM products, VITROTHERM products, fireplace construction materials and other custom items, shipping and packaging fees always apply. FOB merchandise is also shipped at the recipient's risk. Transport is carried out by a transportation company of our choosing. The items that we ship are fragile and we ask that you open any packages in the presence of transportation company personnel to identify any undetected damage. In the event that there are missing, broken or damaged items due to transport, the recipient must immediately provide a written claim to the transportation company upon receipt of the merchandise (by providing detailed information about damage or breakage to items listed in the transportation company's waybill) and this must be confirmed via registered letter within three days from the date the merchandise was received.

#### ART. 4 RETURN OF NEW ITEMS

We are not obligated to accept the return of items for reasons other than those for which we are responsible. If we do decide to accept such a return, the cost of the item invoiced will be repaid, minus a minimum fee of 10% for reconditioning and refurbishing. We will not be held responsible for the cost of the shipping and handling of the returned items.

#### ART. 5 GUARANTEES

KEMP products are guaranteed for one year against manufacturing or material defects if the product is used correctly and in compliance with current DTU standards. The company KEMP et FILS S.A.S is committed to providing or replacing the defective item at no cost. However, travel, labor and shipping costs are the customer's responsibility.

When a defective product is part of a built-in unit, the guarantee only covers the replacement of the defective metal pieces and not the cost of dismantling the unit. Demolition and reconstruction of the built-in unit are not covered by this guarantee. Ceramic fireplace glass is not guaranteed because, while it is heat-resistant, if the glass is struck or there is a mechanical accident, breakage may result. Fire-resistant brick and cast iron are not guaranteed. All electrical materials are guaranteed for only six months and with the condition that they be connected and installed in compliance with the relevant product information.

#### ART. 6 INVOICING

Non-binding. Prices may be adjusted according to COMMODITY prices. WAGES AND SALARY. The minimum amount to be invoiced for any order is €100 (pre-tax). (A fee of €12 will be applied to all invoices of less than €100.) Our regressive quantity discounts are only applied to one item at a time. No cumulative discount will be applied.

#### ART. 7 RESERVE OF TITLE CLAUSE

By explicit agreement, we retain ownership of all merchandise until it has been paid for in full, in compliance with the terms of Law no. 80335 dated 05/12/1980. If the buyer misses any payments, the seller can require restitution of the merchandise of which the seller has retained ownership and the buyer will be obligated to use all means necessary to compensate the seller for said merchandise.

#### CONTESTATION

The Commercial Court of MEAUX has sole jurisdiction. The rights and obligations of the parties are subject solely to French law.

#### TECHNICAL INFORMATION

The dimensions provided in the catalog are considered correct. However, some items are handmade; dimensions can vary during their manufacture. Actual dimensions can vary from stated dimensions between 5 to 10 mm, depending on the item's size.

KEMP reserves the right to modify without notice its manufacturing process or to discontinue products.

#### ART. 8 PAYMENT CONDITIONS

Initial payment is required to be in cash or by cash on delivery.

After required information is provided, subsequent payments are to be made within 30 days after the tenth day of the following month (by electronic check payment or electronic transfer). In the event of payment by installment, the buyer must provide the installments to the seller within the legally-defined limit of 48 hours. Subsequent invoices are payable within 45 days, end of month, or 60 days from the date of the invoice. In the event that amounts due are paid after the date noted on the invoice, penalties will be applied, as authorized by the Law of 8/4/2008, in proportion to the amount of time the payment is overdue; penalties will be calculated from the date payment was due until the day of effective payment, using a rate equal to the three-month EURIBOR rate + 4%. In compliance with the law, these penalties are due without any reminder being required the day following settlement. Full or partial default of payment will trigger the accelerated payment of all remaining amounts and the remaining amounts will become due immediately, even if payment has already been instigated. In the event of non-payment by the buyer, the seller has the right to repossess the merchandise for which payment is due, per deferred transfer-of-title, as noted in article 7.

In addition, we reserve the right to subsequently deliver for cash payment.





Logistique



ZAE La Trentaine 77 507 Chelles CEDEX - FRANCE  
Tél. +33 (0)1 60 08 95 24 • Fax : +33 (0)1 60 08 36 72  
[www.kemp-sa.com](http://www.kemp-sa.com)

