



riscaldatori decorativi da esterno
outdoor decorative heaters

made in italy





gas system

l'emozione della fiamma avvolgente, tecnologia innovativa Italkero!
the emotion of an enchanting flame, innovative Italkero technology!

"GAS SYSTEM", un'idea esclusiva Italkero, è l'innovazione tecnologica a gas nel mondo dei camini che offre risultati eccellenti.
Puoi godere la bellezza della fiamma accendendo il focolare con un telecomando.

*"Gas system" is an exclusive Italkero idea, it's a technological innovation for the gas fireplace world that offers excellent results.
You can enjoy the beauty of the flame simply by turning on the fire with a infrared remote control.*



Le fiamme rappresentate in questo catalogo sono state riprese in un singolo scatto fotografico, non sono e non possono essere in alcun modo vincolanti. L'altezza ed estensione delle fiamme non può essere fissa e standard, ogni fiamma è unica.
*The flames represented in this catalog were shot in a single photograph, they are not and cannot be binding in any way.
The height and extent of the flames cannot be fixed and standard, each flame is unique.*

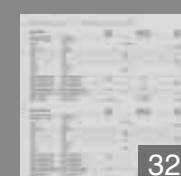
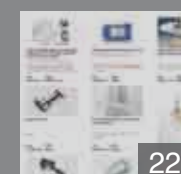
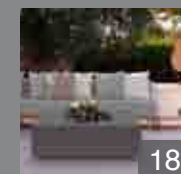
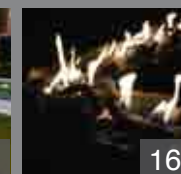
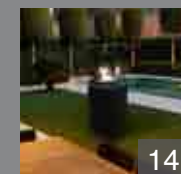
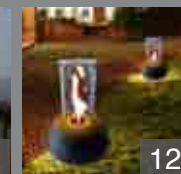
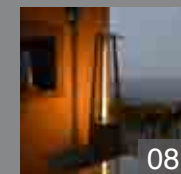
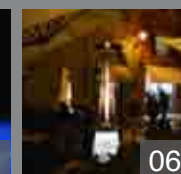
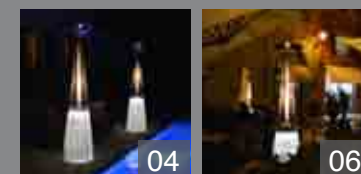

dolce vita

riscaldatori decorativi da esterno
outdoor decorative heaters

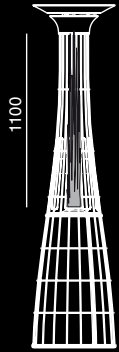

Dolce Vita con luci
Dolce Vita with lights



Dolce Vita con luci
Dolce Vita with lights



Dolce Vita con luci
Dolce Vita with lights

dolce vita E.P. energy producing

riscaldatori decorativi da esterno
outdoor decorative heaters

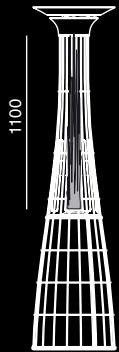

Dolce Vita E.P.
(electricity producing)

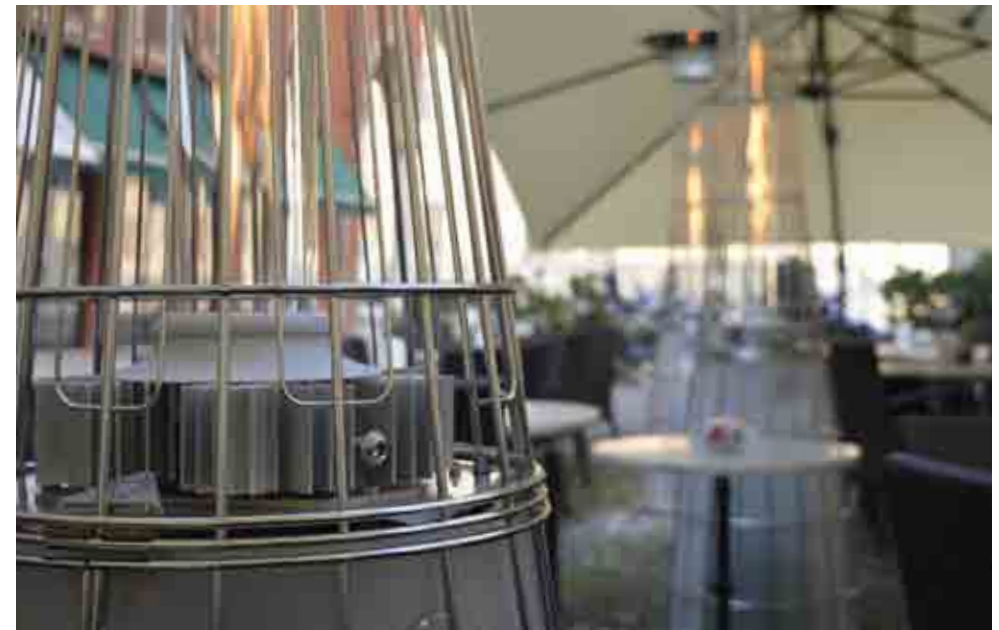

Dolce Vita E.P.
(electricity producing)



Dolce Vita E.P.
(electricity producing)





Falò evo black, riscaldatore da esterno
black Falò evo, *luxury patio heater*



falò evo

riscaldatori decorativi da esterno
outdoor decorative heaters



Falò evo
SILVER



Falò evo
BLACK



Falò evo
doors
CORTEN



Falò evo
CORTEN

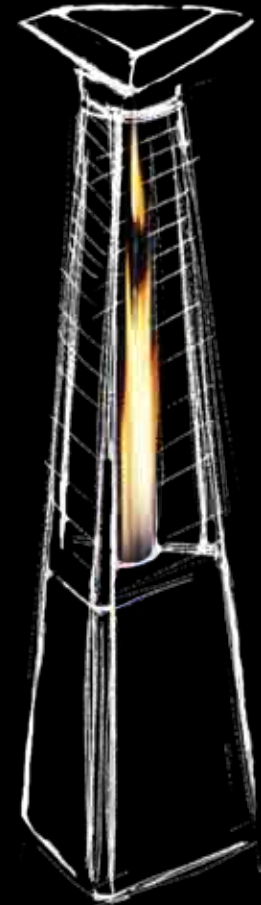
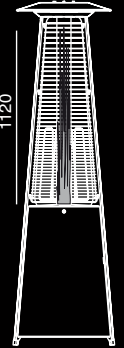



Falò evo black, riscaldatore da esterno
black Falò evo, *luxury patio heater*



falò evo

riscaldatori decorativi da esterno
outdoor decorative heaters



Falò evo
color

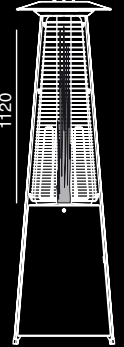

1120

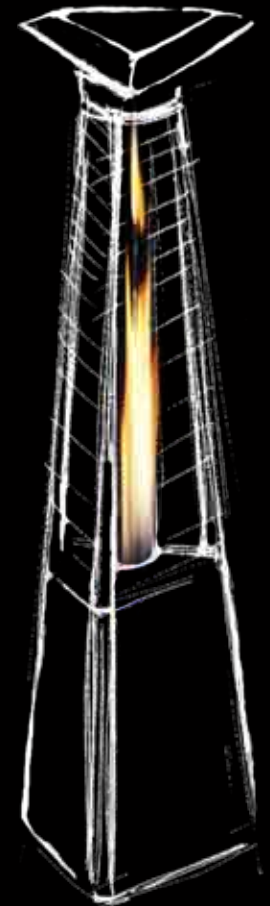

torcia

braciere, installazione esterna
gas fire pits, outdoor installation



inserto
built-in

in rilievo
freestanding



braciere ad incasso,
built-in gas fire pits,



braciere ad incasso,
built-in gas fire pits,

braciere in rilievo
con kit luci led
*freestanding gas fire pits
with led lights kit*





Etna, riscaldatore decorativo da esterno
Etna, decorative outdoor heater



etna

braciere, installazione esterna
gas fire pits, outdoor installation



420

510



snake

inserti braciere, installazione esterna
gas fire logs inserts, outdoor installation

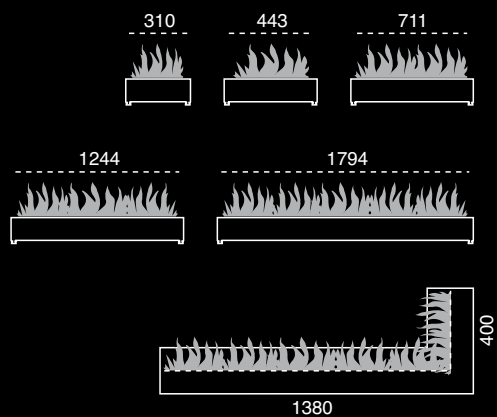

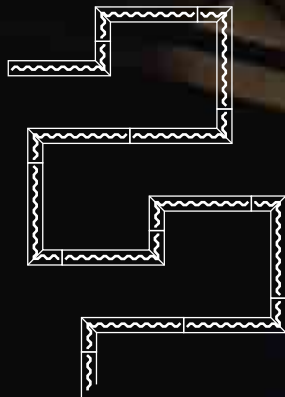
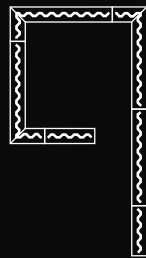
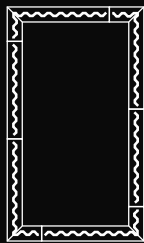
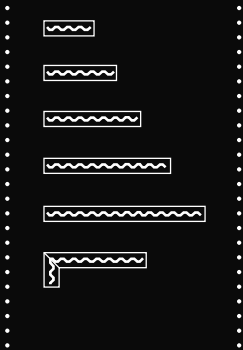

inserto braciere, installazione esterna
gas fire logs insert, outdoor installation



inserto braciere, installazione interna o esterna
gas fire logs insert, indoor or outdoor installation

quadro 40

inserti braciere, installazione interna o esterna
gas fire logs inserts, indoor or outdoor installation



inserto braciere, installazione interna o esterna
gas fire logs insert, indoor or outdoor installation





installazione in porticato
arcade installation



installazione esterna
outdoor installation



spider

ombrello termico da esterno
gas heater for outdoor use

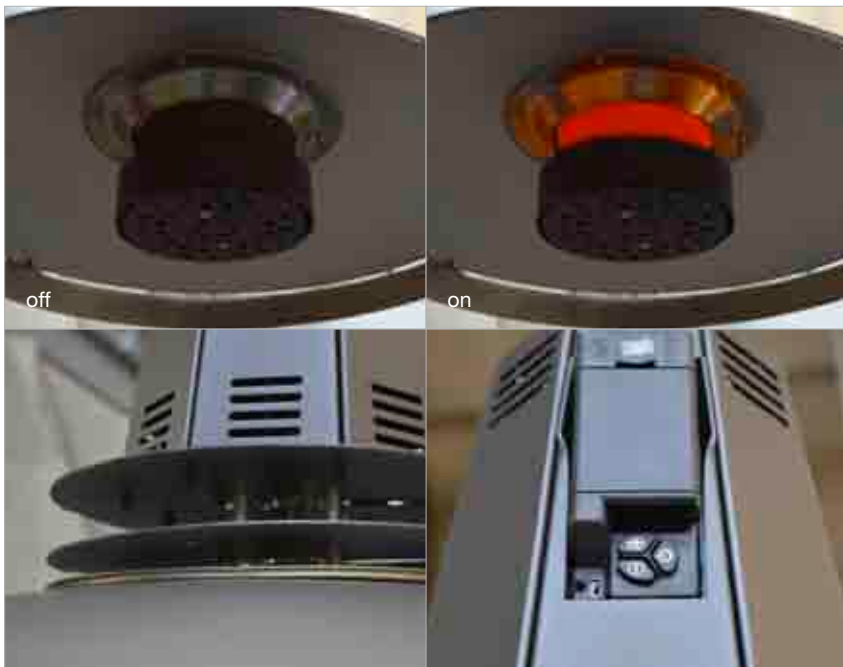

particolari
details

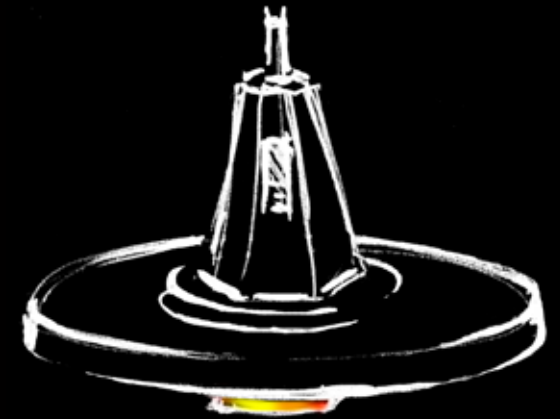

accessori • accessories

DolceVita, DolceVita E.P., Falò EVO, Torcia, Etna, Snake, Quadro, Spider



KIT luci LED SENSOR (attivazione a sfioramento del sensore): luci LED (luce calda), batteria Litio, kit di ricarica, supporto batteria.

NOTA: luci LED già a corredo su modello E.P.

Sensor LED lighting kit: led lights (white warm), rechargeable battery, recharge kit and Lithium battery. NOTE: LED lights supplied for E.P. model.

code model
70001561 00 DolceVita, Torcia.



Batteria addizionale Litio, autonomia circa 10 ore.

NOTA: installabile anche su modello E.P.

Additional rechargeable Lithium battery, working for about 10 hours. NOTE: It can be installed on E.P. model.

code model
70000997 00 DolceVita.



Tavolino Caffè, diametro 80cm (stratificato per utilizzo da esterno, laminato bianco).

Coffee table, external diameter Ø 80cm (stratified for outdoor use, white laminated).

code model
70001571 00 DolceVita.



Cappello grande (diametro esterno Ø75cm).

Larger hat (external diameter Ø 75cm).

code model
70001581 00 DolceVita.



Trolley addizionale per il trasporto.

Additional trolley.

code model
70004566 00 DolceVita.



KIT luci LED: luci LED, batteria, kit di ricarica, supporto batteria.

NOTA: non installabile su modello E.P.

LED Lighting kit: led lights, rechargeable battery, recharge kit and battery support.

NOTE: not for E.P. model.

code model
70006543 00 DolceVita.



Batteria addizionale.

NOTA: non installabile su modello E.P.

Additional rechargeable battery. NOTE: not for E.P. model.

code model
70001562 00 DolceVita.



Kit alimentazione elettrica (3V-35mA), per non sostituire le pile nell'unità ricevente.

Power supply kit (3V - 35mA).

code model
70006071 00 Snake, Quadro, Torcia (L = 185cm).

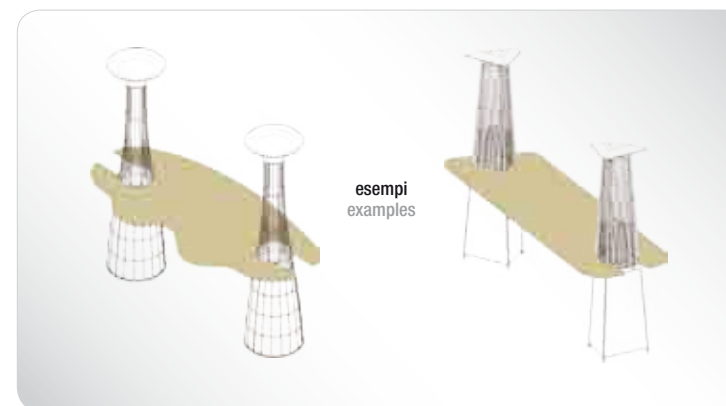

esempi
examples

Piano d'appoggio su misura.

NOTA: contattare l'Uff. Commerciale per definire

- forma desiderata
- dimensione
- tipo di materiale (vetro, legno, ecc.)
- costo e tempi di consegna.

Support plane.

NOTE: contact the Sales office to define

- desired shape
- size
- type of material (glass, wood, etc.)
- cost and delivery times.

code model
000015 DolceVita.
000016 Falò evo.



Ruote per trasporto.

Wheels.

code model
70004567 00 Falò evo.



Tavolino Caffè (stratificato per utilizzo da esterno, laminato bianco).

Coffee table (stratified for outdoor use, white laminated).

code model
70001575 00 Falò evo.



Kit cavo alimentazione elettrica.

Power supply cable kit.

code model
70006581 00 Spider.



Kit rubinetto collegamento gas (3/8").

KIT gas tap connection (3/8").

code model
70000996 00 Snake, Quadro.



Copertura anti pioggia per installazione da esterno in telo PVC.

NOTA: utilizzare ad apparecchio completamente freddo.

PVC fabric rain cover for outside installation.

NOTE: to be used when the device is completely cold.

codice	model
70006575 00	Etna.



Comando manuale a parete con cavo (L 3m).

Wall manual control with cable (L 3m).

code	model
70000994 00	Snake, Quadro.



Sportellino alloggiamento valvola gas.

Gas valve housing door.

code	model	L x L
70006579 00	Snake, Quadro.	320x320



Cablaggio connessione estrattore fumi.

Wiring connection to gas exhauster.

code	model
70006084 00	Snake, Quadro.

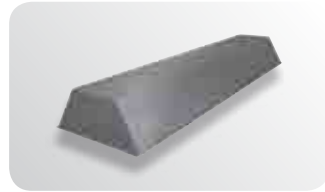

Coperchio anti pioggia per installazione da esterno in acciaio INOX.

INOX stainless steel rain cover for OUTDOOR installation.

code	model	L x L x h
70006508 00	Snake 40	356x379x152
70006509 00	Snake 60	356x512x152
70006510 00	Snake 80	356x780x152
70006511 00	Snake 130	356x1313x152
70006514 00	Snake 180	356x1863x152
70006580 00	Quadro 40	441x1863x152



Kit vetri di protezione e antivento.

Protection and wind shield glass kit.

code	model	L x L x h
70006330 00	Snake 40.	490x400x190
70006331 00	Snake 60.	610x400x190
70006332 00	Snake 80.	880x400x190
70006333 00	Snake 130.	1410x400x190
70006334 00	Quadro 40.	490x400x190



Kit ceppi ceramici con braci.

Log set KIT.

code	model
70006048 00	Snake 40-60, Quadro 40.
70006073 00	Snake 80-130.
70006048 00 + 70006073 00	Snake 180.



Kit ceppi ceramici BIG con braci.

BIG log set KIT.

code	modello
70006588 00	Snake 40-60, Quadro 40.
70006578 00	Snake 80-130.
70006586 00	Snake 180.



Kit ciottoli bianchi di Carrara.

Carrara pebbles KIT.

code	model
70006036 00	Snake 60-80, Quadro 40.
70006037 00	Snake 40, Torcia.
70006039 00	Snake 130.
70006103 00	Snake 180.



tavoli • tops

DolceVita, DolceVita E.P.

tavolino caffè
coffee table

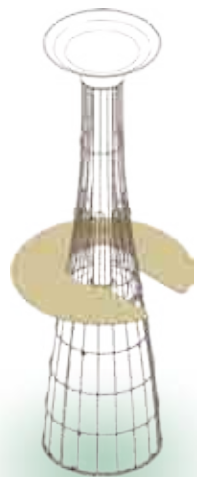

piano d'appoggio tra due apparecchi
table top between two devices

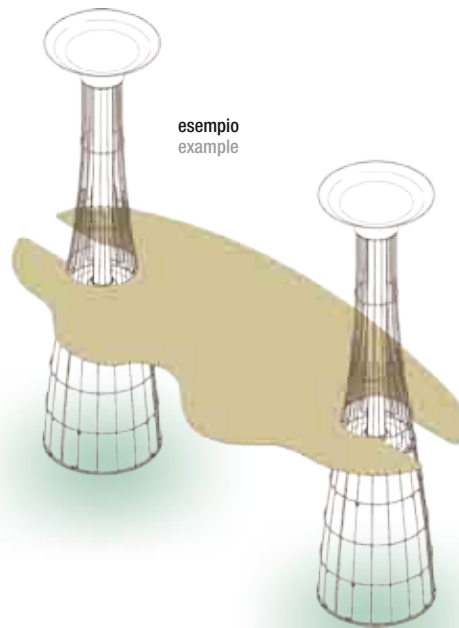
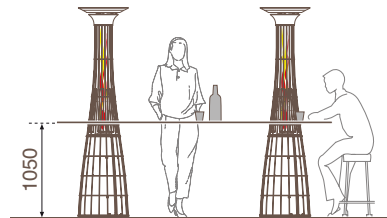

piano d'appoggio tra apparecchio e piede di sostegno (realizzato dall'utente)
table top between the device and foot support (created by the user)

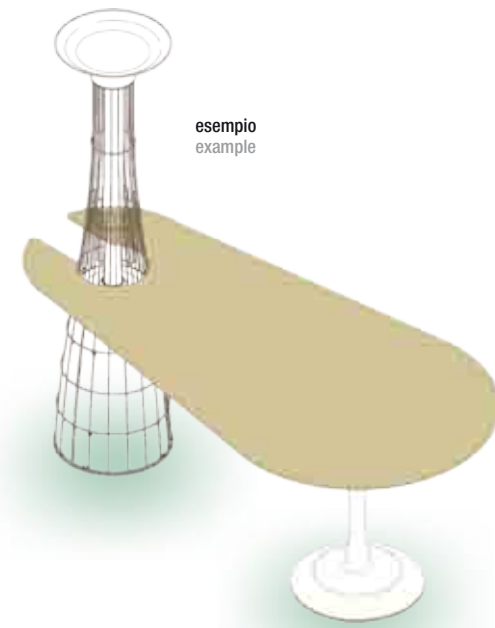
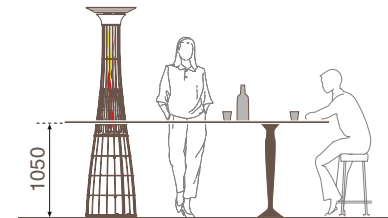

Falò EVO

tavolino caffè
coffee table



piano d'appoggio tra due apparecchi
table top between two devices

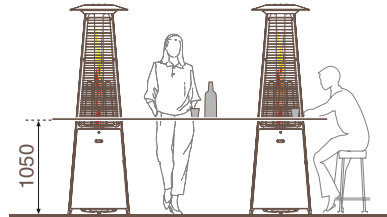

piano d'appoggio tra apparecchio e piede di sostegno (realizzato dall'utente)
table top between the device and foot support (created by the user)

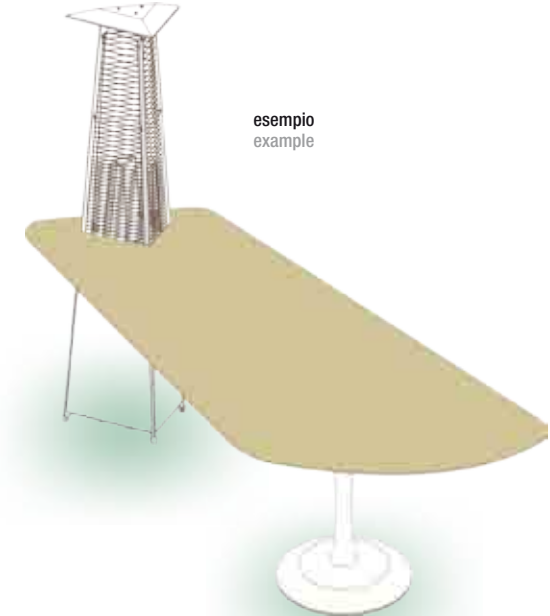
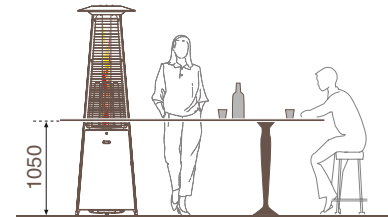

dimensioni • dimensions

DolceVita comando MANUALE DolceVita MANUAL control



Dotazioni:

- trolley per il trasporto
- dispositivo di sicurezza antiribaltamento con blocco automatico alimentazione gas
- struttura in acciaio INOX brillantato
- comando manuale, vari livelli di potenza

Equipped:

- trolley
- anti-tipping device
- polished stainless steel structure
- manual control, various power levels

DolceVita comando INFRAROSSI DolceVita REMOTE control



Dotazioni:

- telecomando
- trolley per il trasporto
- dispositivo di sicurezza antiribaltamento con blocco automatico alimentazione gas
- struttura in acciaio INOX brillantato
- centralina comando con ricevitore, 7 livelli di potenza

Equipped:

- remote control
- trolley
- anti-tipping device
- polished stainless steel structure
- remote control, 7 power levels

DolceVita E.P. comando MANUALE (electricity producing) E.P. DolceVita MANUAL control (electricity producing)



electricity producing



l'accessorio batteria al Litio consente l'accensione delle luci (circa 10 ore) con l'apparecchio non funzionante

this accessory Lithium battery lets you turn on the lights (for about 10 hours) with the unit is not in operation

Dotazioni:

- trolley per il trasporto
- dispositivo di sicurezza antiribaltamento con blocco automatico alimentazione gas
- struttura in acciaio INOX brillantato
- comando manuale, vari livelli di potenza
- luci LED SENSOR (attivazione con sfioramento del sensore) per illuminazione base

Equipped:

- trolley
- anti-tipping device
- polished stainless steel structure
- manual control, various power levels
- sensor LED lighting kit

DolceVita E.P. comando INFRAROSSI (electricity producing) E.P. DolceVita with REMOTE control (electricity producing)



electricity producing



l'accessorio batteria al Litio consente l'accensione delle luci (circa 10 ore) con l'apparecchio non funzionante

this accessory Lithium battery lets you turn on the lights (for about 10 hours) with the unit is not in operation

Dotazioni:

- telecomando
- trolley per il trasporto
- dispositivo di sicurezza antiribaltamento con blocco automatico alimentazione gas
- struttura in acciaio INOX brillantato
- centralina comando con ricevitore, 7 livelli di potenza
- luci LED SENSOR (attivazione con sfioramento del sensore) per illuminazione base

Equipped:

- remote control
- trolley
- anti-tipping device
- polished stainless steel structure
- remote control, 7 power levels
- sensor LED lighting kit

Dolce Vita - manuale • manual
LF10ME M0000
LF10ME L0000

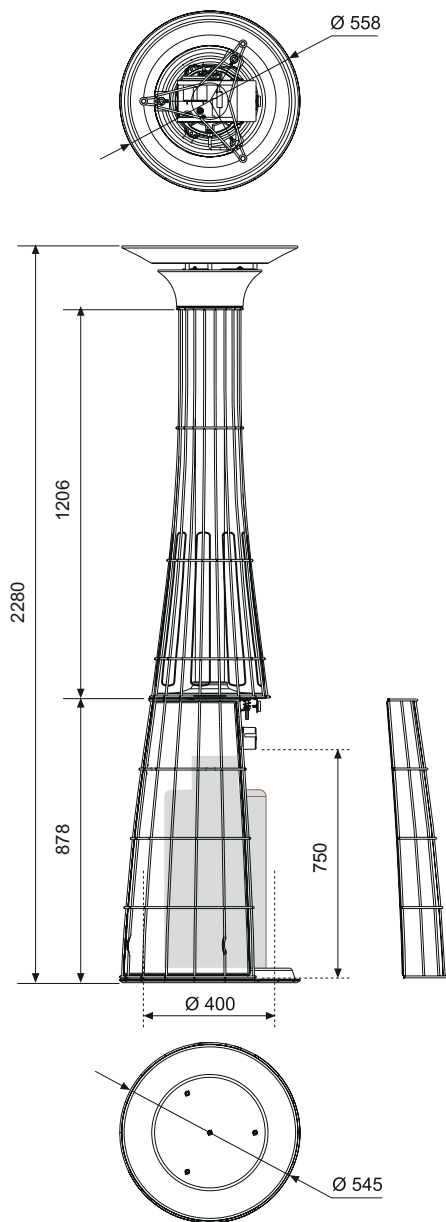

Dolce Vita - infrarossi • remote
LF10AE M0000
LF10AE L0000

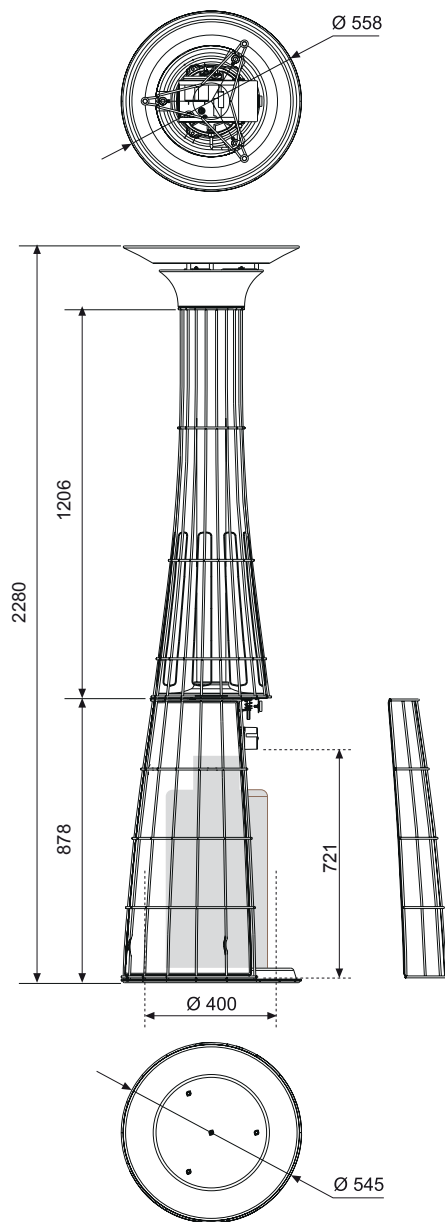

Dolce Vita E.P. - manuale • manual
LF10ME MG000
LF10ME LG000

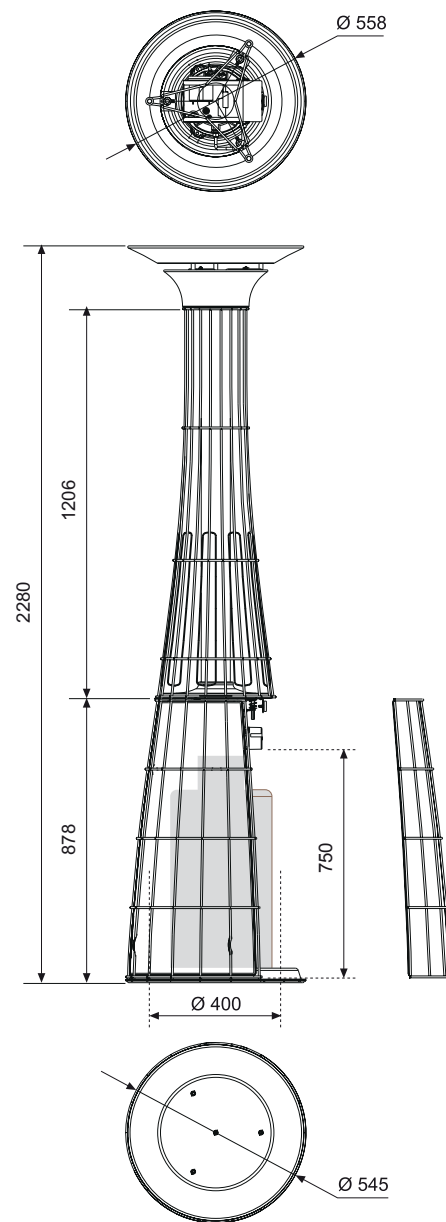

Dolce Vita E.P. - infrarossi • remote
LF10AE MG000
LF10AE LG000

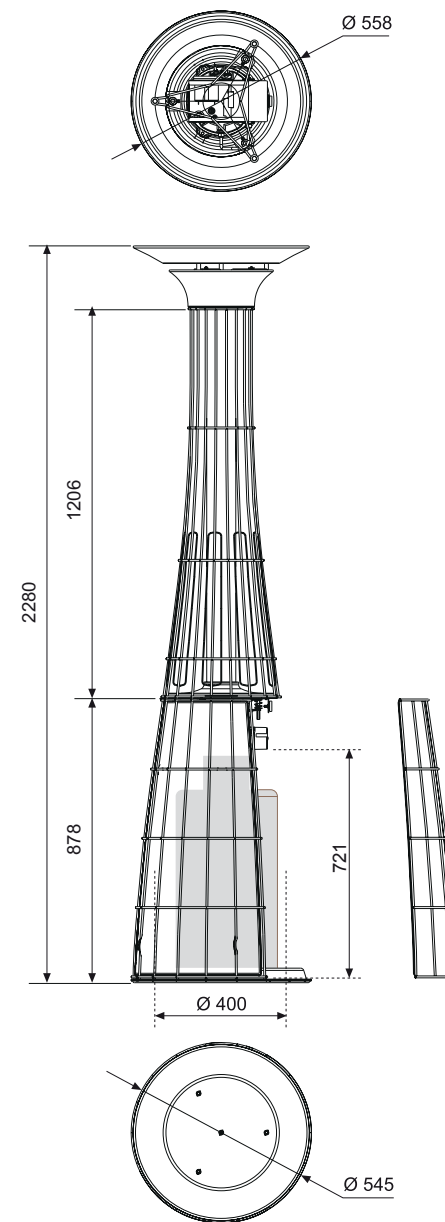

Falò EVO comando MANUALE
Falò EVO MANUAL control

Dotazioni:

- dispositivo di sicurezza antiribaltamento con blocco automatico alimentazione gas
- piedini in gomma antigraffio
- comando manuale, vari livelli di potenza

Equipped:

- anti-tipping device
- rubber feet
- manual control, various power levels



Falò EVO comando INFRAROSSI
Falò EVO REMOTE control



Dotazioni:





- telecomando
- dispositivo di sicurezza antiribaltamento con blocco automatico alimentazione gas
- piedini in gomma antigraffio
- centralina comando con ricevitore, 7 livelli di potenza

Equipped:

- remote control
- anti-tipping device
- rubber feet
- remote control, 7 power levels





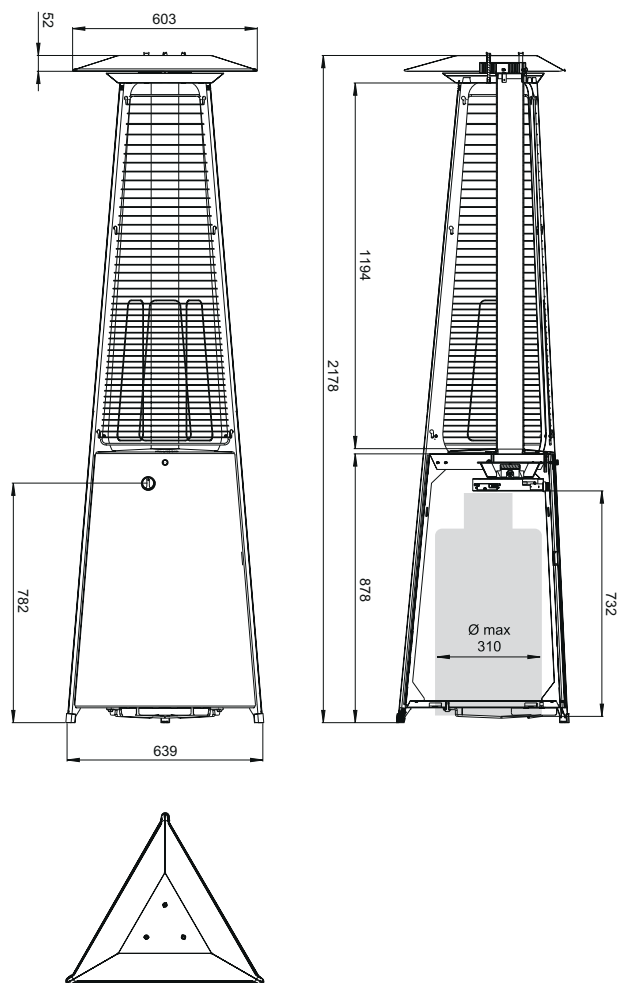

Falò EVO - manuale • manual

Falò evo		FL10ME M0100 FL10ME L0100
Falò evo black		FL10ME M0300 FL10ME L0300
Falò evo ruggine rust		FL10ME M0400 FL10ME L0400
Falò evo color		FL10ME M0200 FL10ME L0200



Falò EVO - infrarossi • remote control

Falò evo		FL10AE M0100 FL10AE L0100
Falò evo black		FL10AE M0300 FL10AE L0300
Falò evo ruggine rust		FL10AE M0400 FL10AE L0400
Falò evo color		FL10AE M0200 FL10AE L0200

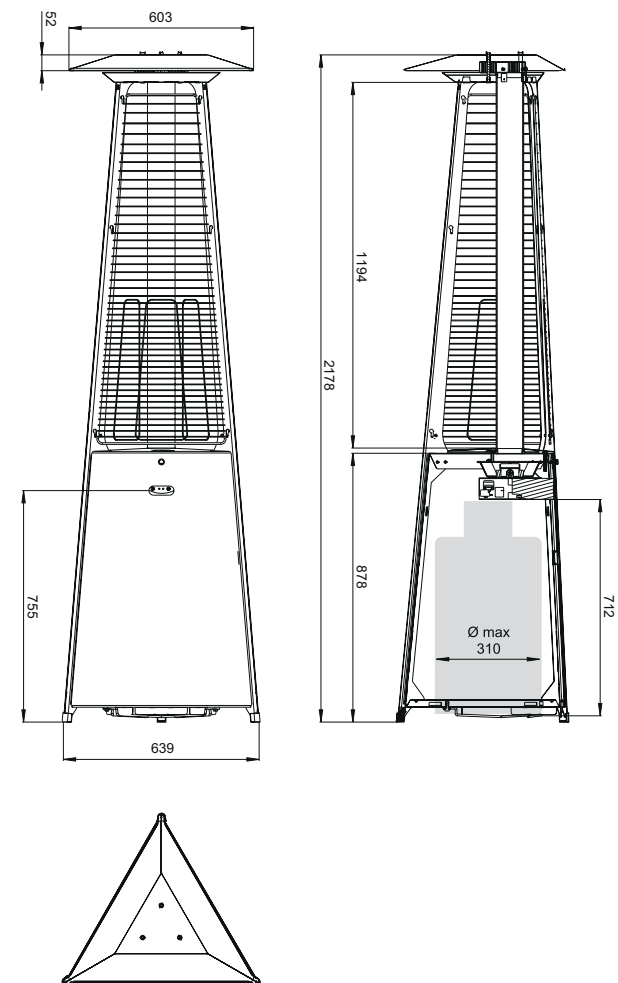

Torcia comando INFRAROSSI - INCASSO
Torcia REMOTE control - Built-in



Dotazioni:

- telecomando base a raggi infrarossi
- centralina comando con ricevitore, 3 livelli di potenza
- cilindro in vetro trasparente

Equipped:

- standard infrared remote control
- remote control model, 3 power levels
- cylinder in transparent glass



Torcia comando INFRAROSSI - IN RILIEVO
Torcia REMOTE control - FREESTANDING



Dotazioni:

- telecomando base a raggi infrarossi
- centralina comando con ricevitore, 3 livelli di potenza
- cilindro in vetro trasparente
- copertura esterna bruciatore

Equipped:

- standard infrared remote control
- remote control model, 3 power levels
- cylinder in transparent glass
- cover external burner



inserti a fiamma libera per uso INTERNO o ESTERNO
gas fire logs for INDOOR or OUTDOOR use



Dotazioni:

- telecomando a raggi infrarossi (senza display)
- struttura in lamiera zincata verniciata
- valvola remotata (indoor)
- valvola remotata + copertura (outdoor)

Equipped:

- remote control (with no display)
- galvanized steel and painted structure
- remote valve (indoor)
- remote valve + cover (outdoor)

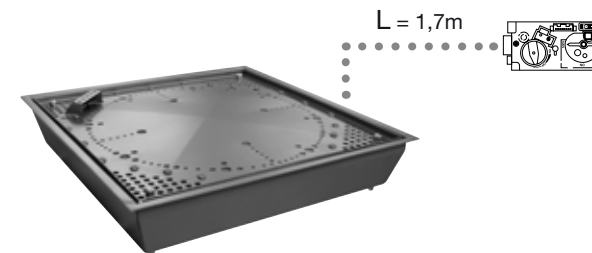

Torcia - infrarossi • remote control

TN09A0 M1000
TN09A0 L1000

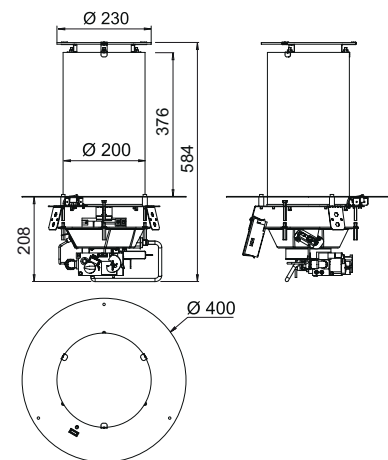

Torcia - infrarossi • remote control

cover GREY



TN09A0 M0000
TN09A0 L0000

cover CORTEN



TN09A0 M0400
TN09A0 L0400

cover COLOR



TN09A0 M0200
TN09A0 L0200

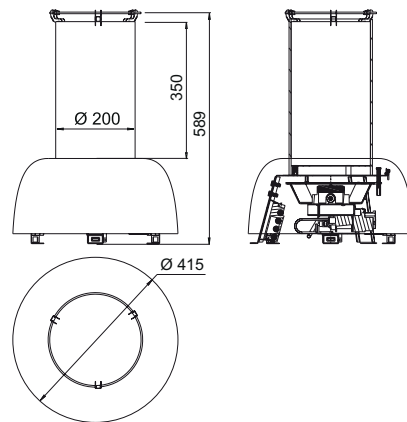

Quadro 40

QO40A0 MI000 (outdoor)
QO40A0 LI000 (outdoor)

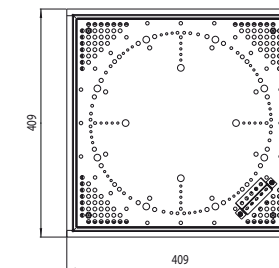
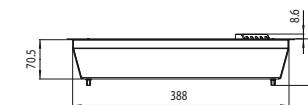

inserti a fiamma libera per uso INTERNO o ESTERNO
gas fire logs for INDOOR or OUTDOOR use

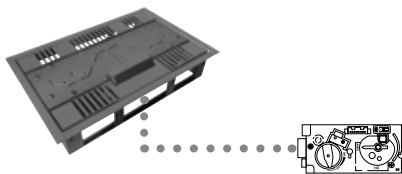

Dotazioni:

- telecomando a raggi infrarossi (senza display)
- struttura in lamiera zincata verniciata
- valvola remotata (modello interno)
- valvola remotata + copertura (modello esterno)

Equipped:

- remote control (with no display)
- galvanized steel and painted structure
- remote valve (indoor model)
- remote valve + cover (outdoor model)

Snake80

- SO09A0 MI000 (outdoor)
- SO09A0 LI000 (outdoor)

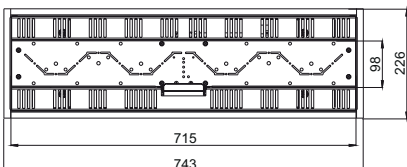
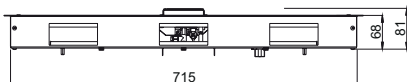

Snake40

- SO05A0 MI000 (outdoor)
- SO05A0 LI000 (outdoor)

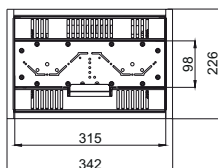
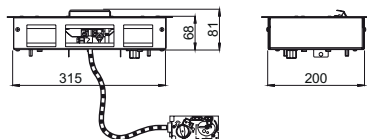

Snake130

- SO13A0 MI000 (outdoor)
- SO13A0 LI000 (outdoor)

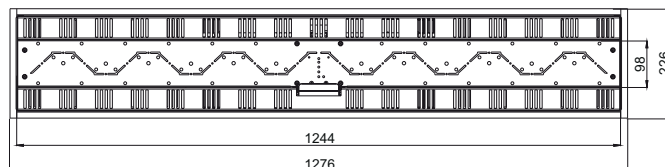
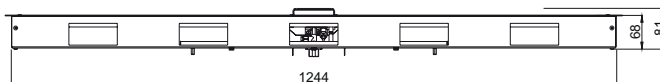

Snake60

- SO07A0 MI000 (outdoor)
- SO07A0 LI000 (outdoor)

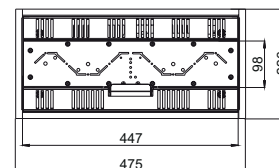
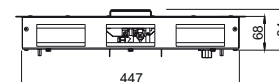

Snake180

- SO18A0 MI000 (outdoor)
- SO18A0 LI000 (outdoor)

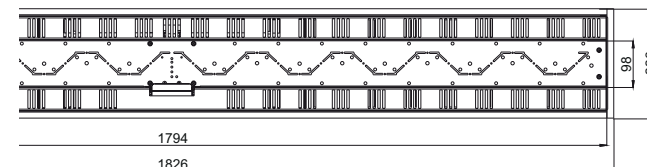
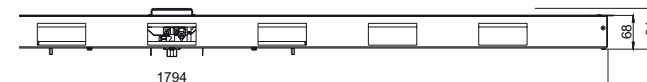

inserti a fiamma libera per uso INTERNO o ESTERNO
gas fire logs for INDOOR or OUTDOOR use



Dotazioni:

- telecomando a raggi infrarossi (senza display)
- struttura in lamiera zincata verniciata
- valvola remotata (modello interno)
- valvola remotata + copertura (modello esterno)

Equipped:

- remote control (with no display)
- galvanized steel and painted structure
- remote valve (indoor model)
- remote valve + cover (outdoor model)

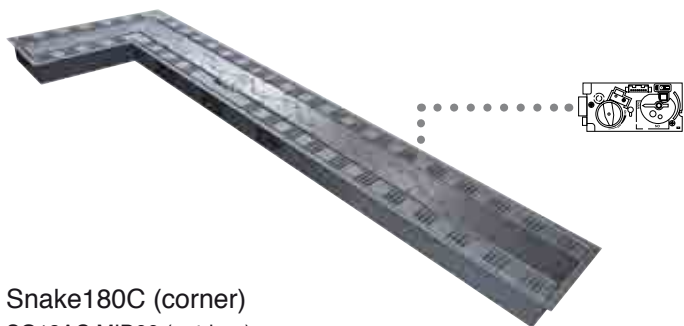

Snake180C (corner)
SO18AC MID00 (outdoor)
SO18AC LID00 (outdoor)

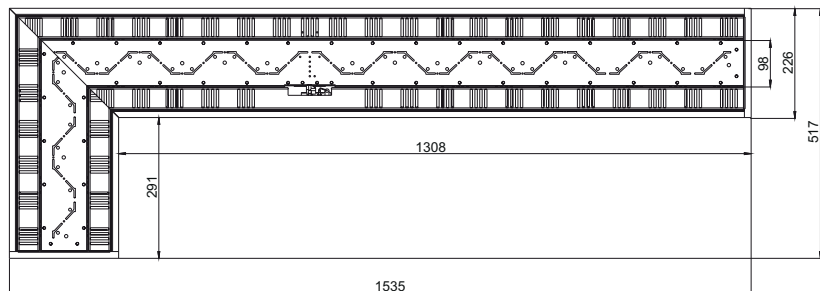
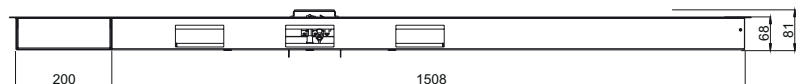

Etna comando MANUALE
Etna MANUAL control

Dotazioni:

- dispositivo di sicurezza antiribaltamento con blocco automatico alimentazione gas
- ruote indipendenti per lo spostamento
- comando manuale, vari livelli di potenza
- KIT sassi di lava e vetro

Equipped:

- anti-tipping device
- independent wheels for moving
- rubber feet
- manual control, various power levels
- lava stones and glass kit



lava rock



glass beads



Etna - manuale • manual
ET07M0 L0000

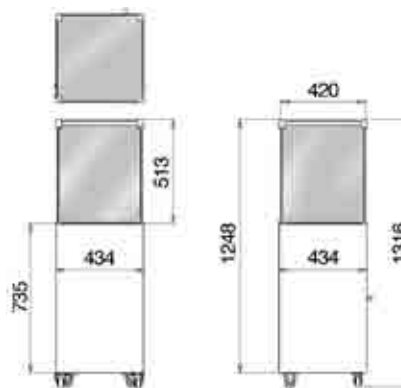

Spider comando INFRAROSSI
Spider REMOTE control



Dotazioni:

- telecomando
- centralina comando con ricevitore, 7 livelli di potenza

Equipped:

- remote control
- remote control, 7 power levels



Spider - infrarossi • remote control
IS07AS M0000
IS07AS L0000

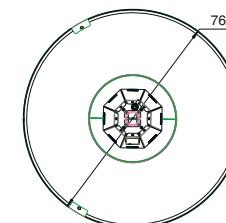
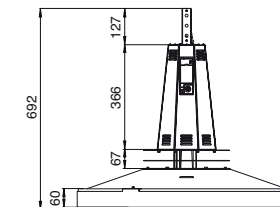

informazioni rapide • quick information

modello model	Dolce Vita comando manuale manual control	Dolce Vita comando infrarossi infrared remote control	Dolce Vita E.P. (electricity producing) comando manuale manual control	Dolce Vita E.P. (electricity producing) comando infrarossi infrared remote control	Falò EVO comando manuale manual control	Falò EVO comando infrarossi infrared remote control
codice GPL code LPG	LF10ME L0000	LF10AE L0000	LF10ME LG000	LF10AE LG000	vedi/see pag.24	vedi/see pag.24
codice Metano code Methane	LF10ME M0000	LF10AE M0000	LF10ME MG000	LF10AE MG000	vedi/see pag.24	vedi/see pag.24
struttura structure	INOX brillantato stainless STEEL	INOX brillantato stainless STEEL	INOX brillantato stainless STEEL	INOX brillantato stainless STEEL	ALLUMINIO + verniciatura ALUMINUM + transparent painted	ALLUMINIO + verniciatura ALUMINUM + transparent painted
vista fiamma h (cm) flame view h	110	110	110	110	112	112
portata (kW) heat input	10,2	10,4	10,2	10,4	10,2	10,4
alimentazione luci LED (V) LED lights power supply	12	12				
peso netto (Kg) net weight	27	28	30	31	28	29
peso lordo (Kg) gross weight	40,5	41,5	43,5	44,5	40,5	41
imballo L x L x h (cm) packaging L x W x h	58 x 58 x 164	58 x 58 x 164	58 x 58 x 164	58 x 58 x 164	64 x 57 x 220	64 x 57 x 220

modello model	Torcia 90 (in rilievo / freestanding) comando infrarossi infrared remote control	Torcia 90 (inserto / built-in) comando infrarossi infrared remote control	Etna comando manuale manual control	Spider comando infrarossi infrared remote control
codice GPL code LPG	TN09A0 L0000	TN09A0 L1000	ET07M0 L0000	IS07AS L0000
codice Metano code Methane	TN09A0 M0000	TN09A0 M1000	-	IS07AS M0000
vista fiamma L x h (cm) flame view L x h	20 x 35	20 x 35	30 x 30	-
portata (kW) heat input	2,95	2,95	7,3	6,5
peso netto (Kg) net weight	8	9	35	10
peso lordo (Kg) gross weight	10	11	40	11 4
imballo L x L x h (cm) packaging L x W x h	60 x 47 x 50	60 x 47 x 50	48 x 48 x 89	33 x 33 x 82 86 x 85 x 11
posizione della valvola gas valve position	sull'apparecchio internal gas valve	sull'apparecchio internal gas valve	sull'apparecchio internal gas valve	sull'apparecchio internal gas valve

modello OUTDOOR <i>OUTDOOR model</i>	Snake 40 inserto <i>insert</i>	Snake 60 inserto <i>insert</i>	Snake 80 inserto <i>insert</i>	Snake 130 inserto <i>insert</i>	Snake 180 inserto <i>insert</i>	Snake 180C inserto <i>insert</i>	Quadro 40 inserto <i>insert</i>
codice GPL <i>code LPG</i>	SO05A0 LI000	SO07A0 LI000	SO09A0 LI000	SO13A0 LI000	SO18A0 LI000	SO18AC LID00	QO40A0 LI000
codice Metano <i>code Methane</i>	SO05A0 MI000	SO07A0 MI000	SO09A0 MI000	SO13A0 MI000	SO18A0 MI000	SO18AC MID00	QO40A0 MI000
vista fiamma L x h (cm) <i>flame view L x h</i>	40 x 40	60 x 40	80 x 40	130 x 40	180 x 40	150 x 50	40 x 40
portata (kW) <i>heat input</i>	8,3	10	10	12	15	15	15,5
peso netto (Kg) <i>net weight</i>	6	7	10	15	19	21	9,5
peso lordo monofaccia tunnel (Kg) <i>gross weight 1 sided 2 sided</i>	7	8,5	12	17,5	22	24	13
imballo L x L x h (cm) <i>packaging L x W x h</i>	69 x 32 x 18	82 x 32 x 18	109 x 32 x 18	162 x 32 x 18	217 x 32 x 18	188 x 51 x 18	
posizione della valvola <i>gas valve position</i>	sportellino esterno <i>external door</i>	sportellino esterno <i>external door</i>	sportellino esterno <i>external door</i>	sportellino esterno <i>external door</i>	sportellino esterno <i>external door</i>	sportellino esterno <i>external door</i>	sportellino esterno <i>external door</i>

dati tecnici • technical data

DolceVita

		manuale manual	telecomandato remote control	manuale manual	telecomandato remote control	
Portata termica nominale	Heat input nom.	10,20	9,00 - 8 (l 2L)	10,20	10,40	kW
Portata termica ridotta (Hs)	Heat input red. (Hs)					
- G20/25	- G20/25		6,0 - 2,0 (l 2L)			kW
- G30/31	- G30/31			4,1 - 5,1 (3B/P 50mbar)	2,5 - 3,0 (3B/P 50mbar)	kW
Consumo orario	Consumption					
- G20	- G20		0,971			m³/h
- G25	- G25		1,129			m³/h
- G30	- G30			742	756	g/h
- G31	- G31			728	743	g/h
Categoria	Gas category					
- G20/25	- G20/25		l 2H · l 2L			
- G30/31	- G30/31				l 3+ (3B/P 50 mbar)	
Pressione alimentazione G20	Pressure supply gas G20	20	20			mbar
Pressione alimentazione G25	Pressure supply gas G25	20 / 25	20 / 25			mbar
Pressione alimentazione G30	Pressure supply gas G30			28-30 (50)	28-30 (50)	mbar
Pressione alimentazione G31	Pressure supply gas G31			37	37	mbar
Diametro ugello bruciatore G20/25	Burner nozzle diameter G20/25	2,30	2,80			mm
Diametro ugello bruciatore G30/31	Burner nozzle diameter G30/31			1,55	1,80 - 1,60 (50 mbar)	mm
Batteria telecomando	Remote control battery	-	nr. 2 x 1,5 (tipo AA)	-	nr. 2 x 1,5 (tipo AA)	V
Batteria U.tà ricevente	Receiver battery	nr. 1 x 1,5 (tipo AA)	nr. 3 x 1,5 (tipo AA)	nr. 1 x 1,5 (tipo AA)	nr. 3 x 1,5 (tipo AA)	V

DolceVita E.P.

		manuale manual	telecomandato remote control	manuale manual	telecomandato remote control	
Portata termica nominale	Heat input nom.	10,20	9,00 - 8 (l 2L)	10,20	10,40	kW
Portata termica ridotta (Hs)	Heat input red. (Hs)					
- G20/25	- G20/25		6,0 - 2,0 (l 2L)			kW
- G30/31	- G30/31			4,1 - 5,1 (3B/P 50mbar)	2,5 - 3,0 (3B/P 50mbar)	kW
Consumo orario	Consumption					
- G20	- G20		0,971			m³/h
- G25	- G25		1,129			m³/h
- G30	- G30			742	756	g/h
- G31	- G31			728	743	g/h
Categoria	Gas category					
- G20/25	- G20/25		l 2H · l 2L			
- G30/31	- G30/31				l 3+ (3B/P 50 mbar)	
Pressione alimentazione G20	Pressure supply gas G20	20	20			mbar
Pressione alimentazione G25	Pressure supply gas G25	20 / 25	20 / 25			mbar
Pressione alimentazione G30	Pressure supply gas G30			28-30 (50)	28-30 (50)	mbar
Pressione alimentazione G31	Pressure supply gas G31			37	37	mbar
Diametro ugello bruciatore G20/25	Burner nozzle diameter G20/25	2,30	2,80			mm
Diametro ugello bruciatore G30/31	Burner nozzle diameter G30/31			1,55	1,80 - 1,60 (50 mbar)	mm
Batteria telecomando	Remote control battery	-	nr. 2 x 1,5 (tipo AA)	-	nr. 2 x 1,5 (tipo AA)	V
Batteria U.tà ricevente	Receiver battery	nr. 1 x 1,5 (tipo AA)	nr. 3 x 1,5 (tipo AA)	nr. 1 x 1,5 (tipo AA)	nr. 3 x 1,5 (tipo AA)	V

Falò EVO

		manuale <i>manual</i>	telecomandato <i>remote control</i>	manuale <i>manual</i>	telecomandato <i>remote control</i>	
Portata termica nominale	<i>Heat input nom.</i>	10,20	9,00 - 8 (l 2L)	10,20	10,40	kW
Portata termica ridotta (Hs)	<i>Heat input red. (Hs)</i>					
- G20/25	- G20/25		6,0 - 2,0 (l 2L)			kW
- G30/31	- G30/31			4,1 - 5,1 (3B/P 50mbar)	2,5 - 3,0 (3B/P 50mbar)	kW
Consumo orario	<i>Consumption</i>					
- G20	- G20		0,971			m³/h
- G25	- G25		1,129			m³/h
- G30	- G30			742	756	g/h
- G31	- G31			728	743	g/h
Categoria	<i>Gas category</i>					
- G20/25	- G20/25		l 2H · l 2L			
- G30/31	- G30/31				l 3+ (3B/P 50 mbar)	
Pressione alimentazione G20	<i>Pressure supply gas G20</i>	20	20			mbar
Pressione alimentazione G25	<i>Pressure supply gas G25</i>	20 / 25	20 / 25			mbar
Pressione alimentazione G30	<i>Pressure supply gas G30</i>			28-30 (50)	28-30 (50)	mbar
Pressione alimentazione G31	<i>Pressure supply gas G31</i>			37	37	mbar
Diametro ugello bruciatore G20/25	<i>Burner nozzle diameter G20/25</i>	2,30	2,80			mm
Diametro ugello bruciatore G30/31	<i>Burner nozzle diameter G30/31</i>			1,55	1,80 - 1,60 (50 mbar)	mm
Batteria telecomando	<i>Remote control battery</i>	-	nr. 2 x 1,5 (tipo AA)	-	nr. 2 x 1,5 (tipo AA)	V
Batteria U.tà ricevente	<i>Receiver battery</i>	nr. 1 x 1,5 (tipo AA)	nr. 3 x 1,5 (tipo AA)	nr. 1 x 1,5 (tipo AA)	nr. 3 x 1,5 (tipo AA)	V

Torcia

		telecomandato <i>remote contro</i>	
Portata termica nominale	<i>Heat input nom.</i>	2,95	kW
Portata termica ridotta (Hs)	<i>Heat input red. (Hs)</i>	1,50	kW
Consumo orario	<i>Consumption</i>		
- G20 / G25	- G20 / G25	0,120	m³/h
- G30 / G31	- G30 / G31	230	g/h
Categoria	<i>Gas category</i>		
- G20/25	- G20/25	l 2E l 2H	
- G30/31	- G30/31	l 3+ l 3B/P	
Tubo attacco gas	<i>Gas connection</i>	3/8"	
Pressione alimentazione G20/G25	<i>Pressure supply gas G20/G25</i>	12	mbar
Pressione alimentazione G30/G31	<i>Pressure supply gas G30/G31</i>	28-30 / 37	mbar
Diametro ugello bruciatore G20/25	<i>Burner nozzle diameter G20/25</i>	1,45	mm
Diametro ugello bruciatore G30/31	<i>Burner nozzle diameter G30/31</i>	0,95	mm
Batteria telecomando	<i>Remote control battery</i>	nr. 1 x 9V PP3	V
Batteria U.tà ricevente	<i>Receiver battery</i>	nr. 3 x 1,5 (tipo AA)	V

modello da INTERNO <i>INDOOR model</i>		Snake 40	Snake 60	Snake 80	Snake 130	Snake 180	Snake 180C	Quadro 40
Portata max/min <i>Heat input max/min</i>	kW	8,3/3,3	10/4	10/4	12/5	15/8	15/8	Met 15,5/6,2 Lpg 14,5/8
Potenza termica nom./rid. Pn <i>Heat output nom./red. Pn</i>	kW	-	-	-	-	-	-	
Tipo scarico <i>Exhaust type</i>		B _{IIAS}	B _{IIAS}	B _{IIAS}	B _{IIAS}	B _{IIAS}	B _{IIAS}	B _{IIAS}
Rendimento <i>Efficiency level</i>	%	-	-	-	-	-	-	
Efficienza <i>Efficiency class</i>	class	-	-	-	-	-	-	
NOx <i>NOx</i>	class	4	4	4	5	5	5	5
Consumo G20 nom./rid. <i>Consumption G20 nom./red.</i>	m³/h	0,878/0,349	1,057/0,423	1,057/0,423	1,269/0,529	1,586/0,846	1,586/0,846	1,639/0,656
Consumo G30 nom./rid. <i>Consumption G30 nom./red.</i>	Kg/h	0,654/0,256	0,788/0,315	0,788/0,315	0,946/0,394	1,182/0,630	1,182/0,630	1,143/0,630
Consumo G31 nom./rid. <i>Consumption G31 nom./red.</i>	Kg/h	0,644/0,256	0,776/0,310	0,776/0,310	0,931/0,388	1,164/0,621	1,164/0,621	1,126/0,621
Pressione nom. alimentazione G20/G30-G31 <i>Pressure nom. supply G20/G30-G31</i>	mbar	20 / 28-30/37	20 / 28-30/37	20 / 28-30/37	20 / 28-30/37	20 / 28-30/37	20 / 28-30/37	20 / 28-30/37
Pressione nom. ugelli G20/G30-G31 <i>Pressure nom. nozzles G20/G30-G31</i>	mbar	10,9 / 28,6/36,5	11,1 / 28,6/36,5	11,1 / 28,6/36,5	10,1 / 28,6/36,5	11 / 28,6/36,5	11 / 28,6/36,5	15 / 28,6/36,6
Pressione nom. ugelli G20/G30-G31 rid. <i>Pressure nom. nozzles G20/G30-G31 red.</i>	mbar	2/4,9-6,3	2/5,6-7,4	2/5,6-7,4	2/3,3-4,0	3/9-11	3/9-11	3/8,4
Diametro ugello bruciatore G20/G30-G31 <i>Diameter burner nozzle G20/G30-G31</i>	mm	2,5/1,45	2,9/1,6	2,9/1,6	2,3/1,25	2,5/1,4	2,5/1,4	3,3/1,98
Ugello bruciatore <i>Burner nozzle</i>	nr.	1	1	1	2	2	2	1
Ugello pilota G20/G30-G31 <i>Pilot nozzle G20/G30-G31</i>	code	0,35/0,25	0,35/0,25	0,35/0,25	0,35/0,25	0,35/0,25	0,35/0,25	0,35/0,25
Alimentazione (accessorio) <i>Power supply (optional)</i>	V	230VAC / 6VCC	230VAC / 6VCC	230VAC / 6VCC	230VAC / 6VCC	230VAC / 6VCC	230VAC / 6VCC	230VAC / 6VCC
Potenza assorbita <i>Power input</i>	W	0	0	0	0	0	0	0
Diametro tubo attacco gas <i>Diameter gas connection pipe</i>	mm	3/8" - Ø10	3/8" - Ø10	3/8" - Ø10	3/8" - Ø10	3/8" - Ø10	3/8" - Ø10	3/8" - Ø10
Batterie telecomando (1 pz.) <i>Remote control battery</i>	type	9V PP3	9V PP3	9V PP3	9V PP3	9V PP3	9V PP3	9V PP3
Batterie U.tà ricevente (4 pz.) <i>Receiver battery</i>	type	1,5V AA	1,5V AA	1,5V AA	1,5V AA	1,5V AA	1,5V AA	1,5V AA
Protezione <i>Electrical protection</i>		IP20	IP20	IP20	IP20	IP20	IP20	IP20
Categoria gas <i>Gas category</i>		3 _P -30, 3 _{B/P} -37, 3 _{B/P} -50, 3 ₊ , 2 _H , 2 _E , 2 _{E(R)} , 2 _{Er}	3 _P -30, 3 _{B/P} -37, 3 _{B/P} -50, 3 ₊ , 2 _H , 2 _E , 2 _{E(R)} , 2 _{Er}	3 _P -30, 3 _{B/P} -37, 3 _{B/P} -50, 3 ₊ , 2 _H , 2 _E , 2 _{E(R)} , 2 _{Er}	3 _P -30, 3 _{B/P} -37, 3 _{B/P} -50, 3 ₊ , 2 _H , 2 _E , 2 _{E(R)} , 2 _{Er}	3 _P -30, 3 _{B/P} -37, 3 _{B/P} -50, 3 ₊ , 2 _H , 2 _E , 2 _{E(R)} , 2 _{Er}	3 _P -30, 3 _{B/P} -37, 3 _{B/P} -50, 3 ₊ , 2 _H , 2 _E , 2 _{E(R)} , 2 _{Er}	3 _P -30, 3 _{B/P} -37, 3 _{B/P} -50, 3 ₊ , 2 _H , 2 _E , 2 _{E(R)} , 2 _{Er} , 2 _{EK}
Diametro tubo scarico STANDARD <i>STANDARD flue line</i>	mm	MIN 180	MIN 180	MIN 180	MIN 180	MIN 180	MIN 180	MIN 180
Diametro tubo scarico ACCESSORIO <i>OPTIONAL flue line</i>	mm	-	-	-	-	-	-	-

modello da INTERNO <i>INDOOR model</i>		Etna	Spider
Portata max/min <i>Heat input max/min</i>	kW	7,3	6,5
Potenza termica nom./rid. Pn <i>Heat output nom./red. Pn</i>	kW	-	6,5 / 4,0
Tipo scarico <i>Exhaust type</i>		A	A1
Rendimento <i>Efficiency level</i>	%	-	-
Efficienza <i>Efficiency class</i>	class	-	-
NOx <i>NOx</i>	class	-	-
Consumo G20 nom./rid. <i>Consumption G20 nom./red.</i>	m³/h	-	0,687 / 0,423
Consumo G30 nom./rid. <i>Consumption G30 nom./red.</i>	Kg/h	0,531	0,512 / 0,315
Consumo G31 nom./rid. <i>Consumption G31 nom./red.</i>	Kg/h	0,522	0,505 / 0,310
Pressione nom. alimentazione G20/G30-G31 <i>Pressure nom. supply G20/G30-G31</i>	mbar	28-30 / 37	only G31 37,0
Pressione nom. ugelli G20/G30-G31 <i>Pressure nom. nozzles G20/G30-G31</i>	mbar	28-30 / 37	only G31 36,5
Pressione nom. ugelli G20/G30-G31 rid. <i>Pressure nom. nozzles G20/G30-G31 red.</i>	mbar	-	only G31 11,0
Diametro ugello bruciatore G20/G30-G31 <i>Diameter burner nozzle G20/G30-G31</i>	mm	1,32	1,25
Ugello bruciatore <i>Burner nozzle</i>	nr.	1	1
Ugello pilota G20/G30-G31 <i>Pilot nozzle G20/G30-G31</i>	code	0,25	0,25
Alimentazione (accessorio) <i>Power supply (optional)</i>	V	-	5VCC
Potenza assorbita <i>Power input</i>	W	0	0
Diametro tubo attacco gas <i>Diameter gas connection pipe</i>	mm	3/8" - F 1/2"	1/2" - Ø25
Batterie telecomando (2 pz.) <i>Remote control battery</i>	type	-	1,5V AA
Batterie U.tà ricevente (3 pz.) <i>Receiver battery</i>	type	-	1,5V AA
Protezione <i>Electrical protection</i>		-	IP23
Categoria gas <i>Gas category</i>		I3 - I3 _{B/P} (30 mbar) I3 _{B/P} (50 mbar)	3P-37 / 3P50 2E 2H 2E+ (20) / 2LL-20
Diametro tubo scarico STANDARD <i>STANDARD flue line</i>	mm	-	-
Diametro tubo scarico ACCESSORIO <i>OPTIONAL flue line</i>	mm	-	-



comando • remote

falò evo, dolcevita, spider



Telecomando:

- On / Off.
- Aumento/Diminuzione della fiamma.
- tasto SET, riconoscimento telecomando.
- spia luminosa di malfunzionamento.
- spia luminosa di riconoscimento.

Remote control:

- On / Off.
- Thermostat knob regulation.
- Manual or timer program.
- Malfunction indicator light.
- Recognition indicator light.

snake, quadro, torcia



Telecomando infrarossi:

- Off.
- On/Aumento/Diminuzione della fiamma.
- Led luminoso (trasmissione comando).

Infrared remote control:

- Off appliance.
- On/Thermostat knob regulation.
- Warning light transmission control



made in  italy

made in **italy**



Italkero s.r.l. Via Lumumba, 2 - 41122 Modena | T. +39 059 2550711 | F. +39 059 4900500 | info@italkero.it | www.italkero.it | www.italkero.com

NOTA: Nel continuo perfezionamento del prodotto, le caratteristiche estetiche e dimensionali, i dati tecnici, gli equipaggiamenti e gli accessori, possono essere soggetti a variazione.
NOTE: Prices and specifications are correct at date of publication but subject to availability or change without notice.